



フェニックスエンドミルシリーズ

Vol.10

PHX

Phoenix End Mill Series

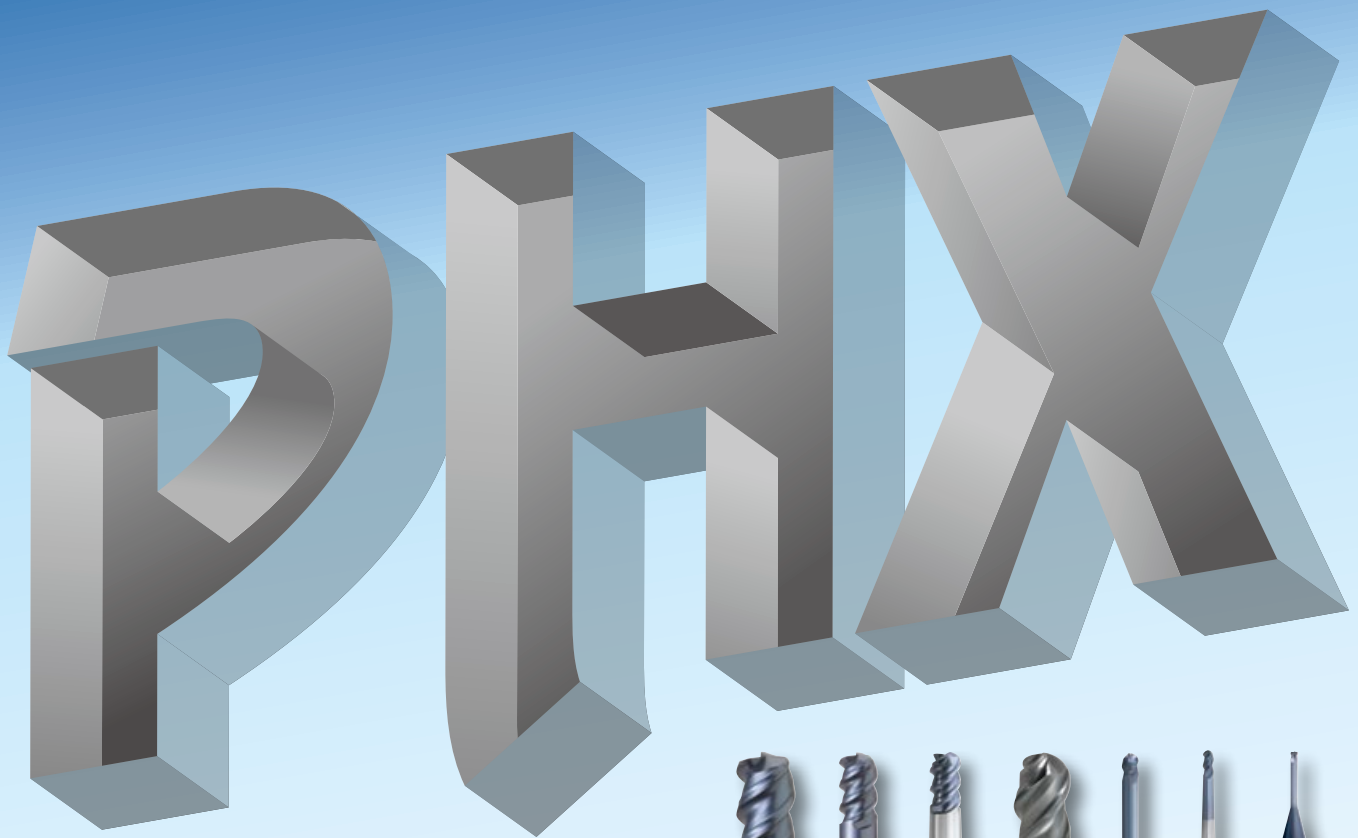

PHX End Mill Series

ラインナップ Lineup

ディープフィーダーブルノーズ

Deep feeder bull nose end mill

深切込みが可能な強力型ブルノーズタイプ

Heavy-duty type for deep milling

PHX-DFR (P.9)



ペンシルネックディープフィーダーブルノーズ PHX-PC-DFR (P.10)

Pencil neck deep feeder bull nose end mill

強力型 PHX-DFR のペンシルネックタイプ

Pencil neck version of PHX-DFR



ロングネックディープフィーダーブルノーズ PHX-LN-DFR (P.15)

Long neck deep feeder bull nose end mill

強力型 PHX-DFR のロングネックタイプ

Long neck version of PHX-DFR



4枚刃小径ロングネックブルノーズ

4-flute long neck small bull nose end mill

高鋼度材の高送りでも抜群の仕上げ面を実現するブルノーズタイプ

Provides excellent surface finish under high feed rate condition

PHX-LN-CRE (P.17)



ディープフィーダーボール

Deep feeder ball nose end mill

深切込みが可能な強力型ボールタイプ

Heavy-duty type for deep milling

PHX-DBT (P.18)



ペンシルネックディープフィーダーボール

Pencil neck deep feeder ball nose end mill

強力型 PHX-DBT のペンシルネックタイプ

Pencil neck version of PHX-DBT

PHX-PC-DBT (P.19)



ロングネックボール

3-flute long neck ball nose end mill

安定した荒加工やリブ溝加工が可能なロングネックタイプ

Applicable to rough milling and rib milling

PHX-LN-DBT (P.27)



ハイフィーダーブルノーズ

High feeder bull nose end mill

高送り加工に専用設計されたブルノーズタイプ

High-feed type

PHX-CRT (P.28)



限界と思われたその加工能率 Milling efficiency beyond expectation

PHXエンドミルで驚愕の時間短縮が可能に! Dramatically shorten machining time with the PHX end mill!

通常の深掘り加工では…
Deep milling in general ...

工具突出しを長くする必要がある
Requires long overhang length

加工条件を落とさないように太径工具(例: φ20 ~) を使用するなどして剛性を確保しなければならない
Large diameter tools (e.g. φ20 or above) are used to ensure rigidity in order to maintain normal cutting condition

削り残し代が多くなり次工程に負担がかかる
Large diameter end mills leave behind many uncut regions, placing more burden on the next process

工程数、工具本数共に多くなり加工時間も長くなってしまふ
The number of processes and tools required are increased, resulting in long processing time

PHXでは…
In the case of PHX ...

工具突出しが長くても、最適加工条件を設定することにより能率を落とさず加工可能
Normal cutting condition can be applied even with long overhang length

工具径もφ10からスタートでき、削り残し代を少なくできる
Sizes as small as φ10 can be used, which can reduce the amount of uncut regions

工程数、工具本数、加工時間を大幅に削減可能!
The number of processes, tools used and machining time are drastically reduced!

その秘訣は次ページにて!!
Discover the secrets to the PHX's superior performance on the next page!

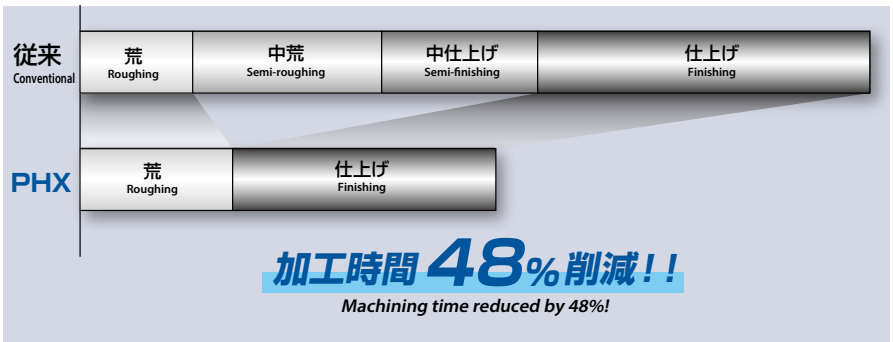
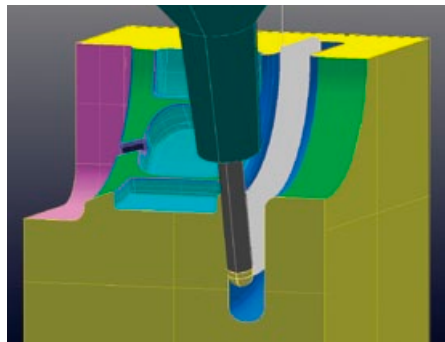

被削材: NAK80(40HRC)

Work Material

使用機械: 5軸加工機
Machine: Five-axis Machining Center

主軸タイプ: HSK A63タイプ
Main Spindle

切削油剤: なし(エアブロー)
Coolant: Air Blow

最高回転数: 18,000min⁻¹
Maximum RPM

ホルダ: 焼ばめホルダ
Holder: Shrink Fit

工程番号 Process	加工内容 Milling Process	使用工具 Tool	突出し量 Overhang Length	回転速度 (min ⁻¹) Speed	送り速度 (mm/min) Feed	軸方向 切込深さ (mm) ap	径方向 切込深さ (mm) pf	残り代 (mm) Stock to Leave	切削距離 (m) Milling Length	切削時間 Milling Time
1	等高線荒取り加工 (ピンク) Contour roughing (pink)	PHX-DFR 10×R2	25.0	3,800	2,100	0.50	2.50	0.1	15.4	0:07:16
2	側面切削仕上げ加工 (ピンク) Side finish milling (pink)	↓	25.0	3,800	600	—	2.40	0	376.0	0:00:50
3	等高線荒取り加工 (グリーン) Contour roughing (green)	↓	25.0	2,400	2,100	0.50	2.50	0.05	20.1	0:08:37
4	傾斜軸固定面扱い加工 (グリーン) Fixed inclined-axis surface milling (green)	↓	25.0	3,800	1,000	—	0.20	0	8.9	0:10:42
5	面扱い等高線荒取り加工 (ブルー) Contour surface roughing (blue)	PHX-LN-DBT R2×20	23.0	7,600	1,550	0.25	1.00	0.01	17.5	0:13:46
6	面扱い等高線仕上げ加工 (ブルー) Contour surface finish milling (blue)	↓	23.0	5,500	1,350	0.12	0.10	0	16.2	0:10:40
7	面扱い等高線荒取り加工 (スカイブルー) Contour surface roughing (cyan)	PHX-LN-DBT R1.5×12	14.0	12,000	1,700	0.30	0.70	0.05	14.0	0:09:26
8	面扱い等高線仕上げ加工 (スカイブルー) Contour surface finish milling (cyan)	↓	14.0	11,000	2,050	0.09	0.10	0	9.5	0:04:31
9	面扱い周回仕上げ加工 (スカイブルー) Circumferential surface finish milling (cyan)	↓	14.0	11,000	2,050	—	0.08	0	5.4	0:02:49
10	面扱い加工 (角R部) (スカイブルー) Surface milling (rounded corners) (cyan)	↓	14.0	11,000	2,050	—	0.08	0	5.4	0:03:12
11	取り残し加工 (スカイブルー) Milling of remaining areas (cyan)	PHX-LN-DBT R0.75×6	13.0	16,000	960	0.04	0.04	0	18.4	0:24:54
12	面扱い等高線荒取り加工 (グレー) Contour surface roughing (gray)	PHX-LN-DBT R0.5×4	12.0	18,000	1,000	0.05	0.16	0	9.0	0:09:45
13	面扱い等高線仕上げ加工 (グレー) Contour surface finish milling (gray)	↓	12.0	18,000	900	—	0.03	0	339.0	0:00:29

トータル加工時間 1:46:57
Total operation time



特長
Features

ボールノーズ
Ball Nose

ボールノーズ
Ball Nose

ボールノーズ
Ball Nose

ボールノーズ
Ball Nose

ボールノーズ
Ball Nose

ボールノーズ
Ball Nose

ボールノーズ
Ball Nose

ボールノーズ
Ball Nose

ボールノーズ
Ball Nose

ボールノーズ
Ball Nose

ボールノーズ
Ball Nose

ボールノーズ
Ball Nose

ボールノーズ
Ball Nose

ボールノーズ
Ball Nose

ボールノーズ
Ball Nose

ボールノーズ
Ball Nose

ボールノーズ
Ball Nose

ボールノーズ
Ball Nose

ボールノーズ
Ball Nose

ボールノーズ
Ball Nose

ボールノーズ
Ball Nose

ボールノーズ
Ball Nose

切削条件
Cutting Conditions

2

幅広い加工に対応!

ブルノーズシリーズ! PHX-DFR

Compatible with a wide range of applications! Deep Feeder Bull Nose Series!

従来品ハイフィーダーブルノーズ(PHX-CRT)の3次元ネガ形状に、ディープフィーダーボールシリーズの **Thermolysis 効果** をプラス! 究極のブルノーズで、びびり易い深い部位の加工や難削材加工に、より高能率を実現します!

In addition to the negative shape of the conventional PHX-CRT high feeder bull nose, it achieves the thermolysis effect. The superior bull nose performs exceptionally well when making deep cuts that are ordinarily susceptible to chattering or when working in materials that are difficult to machine.

ハイフィーダーブルノーズ(PHX-CRT)のR精度は±0.01mm、ディープフィーダーブルノーズシリーズは±0.03mm。ディープフィーダーブルノーズシリーズとハイフィーダーブルノーズ(PHX-CRT)は、要求R精度に応じて、使い分けて下さい。

The precision of the PHX-CRT high feeder bull nose is ± 0.01 mm, and the deep feeder bull nose series is ± 0.03 mm. Use the deep feeder bull nose series or the PHX-CRT high feeder bull nose to suit your radius precision requirements.

Thermolysis 効果とは The Thermolysis Effects are...

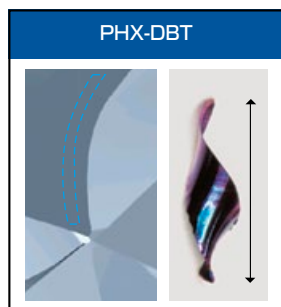

強スパイラルギャッシュにより切れ刃が長くなり、その厚さが薄くなることで、切削熱も伝わりやすく、工具刃先や被削材に熱が残りにくい。

Due to the strong spiral gash, the cutting edge becomes longer and thinner. It becomes easier to dissipate cutting heat and the cutting edge and workpiece are less effected by heat buildup.

3次元ネガ形状とは A Three-Dimensional Negative Form is...

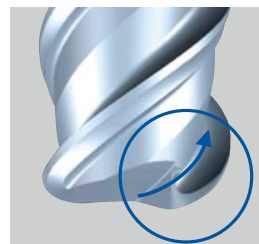

- ① 中心部は切れ味を持たせるためにすくい角を強くし、外周部にかけて剛性を持たせるため、すくい角を弱くしている。
- ② 切りくずの流動性を向上させ、切削熱を低減し長寿命化を図る。

1. A form where the weaker central portion of the cutting edge has a slight negative angle, and the easily broken outer portion has a strong negative angle.
2. Designed for long tool life by increasing chip evacuation and reducing heat buildup.

ねじれ角による効果 (同切込みでの比較) Effect based on helix angle (comparison of cut length)

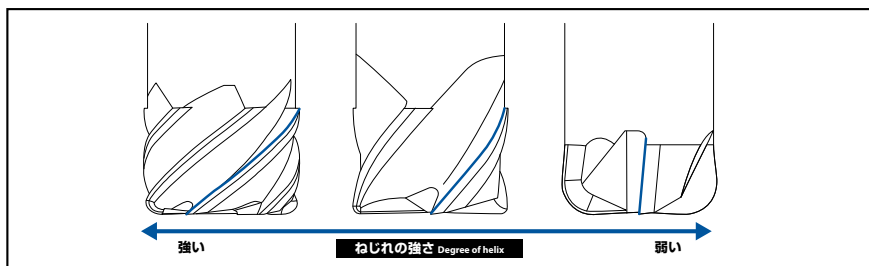

例 一刃切込みが0.2mm(t=0.2)の場合の刃先のねじれによる切りくずのイメージ ※R形状無視
Ex. Images of cutting chips produced based on helix angle where the cutting length is 0.2 mm (t = 0.2 mm) ※ Radius ignored

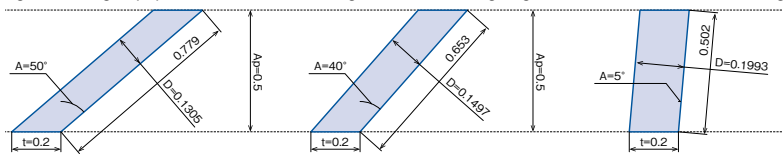

あくまでも二次元的な表現です。実際の加工とは異なります。
The above is strictly a conceptual analysis. Result may vary based on actual milling.

切削条件が同じ場合、切りくずの体積は変わらないが、切りくずの形状が変わることで発熱量も抵抗も変わる。

Even if are milling conditions identical, the volume of the cutting chips are the same, but the amount of resistance and heat released will differ based on the change in chip shape.

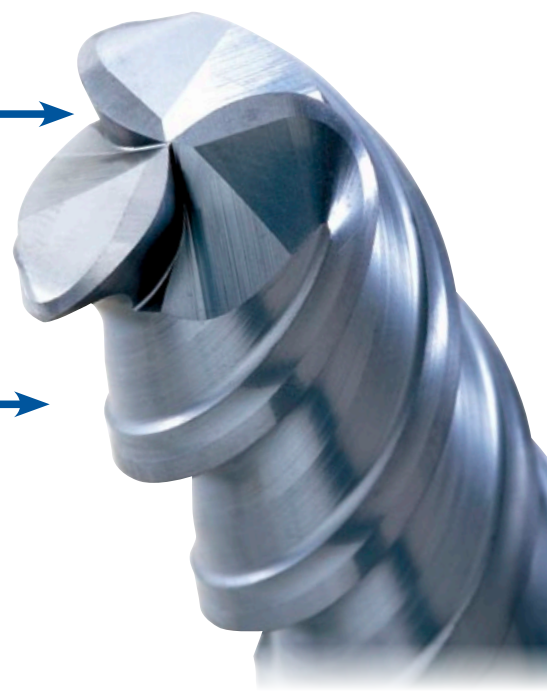

ディープフィーダーブルノーズシリーズで、直彫加工領域を拡大頂き、びびりを回避した高精度な荒加工で、更なる生産性向上に挑戦下さい。

Use the deep feeder bull nose series to expand the scope of your mold milling work, and improve your productivity further more through high-precision roughing without chattering.

ディープフィーダーブルノーズシリーズは、3種類をご用意。幅広い加工に対応します!

Three types of deep feeder bull nose series are available for a wide range of milling work.

- 標準形状 PHX-DFR
Standard shape
- ロングネック形状 PHX-LN-DFR
Long neck shape
- ペンシルネック形状 PHX-PC-DFR
Pencil neck shape



PHX-DFRによる深リブ加工 L/D=20超え

Deep rib milling by the PHX-DFR L/D=over 20

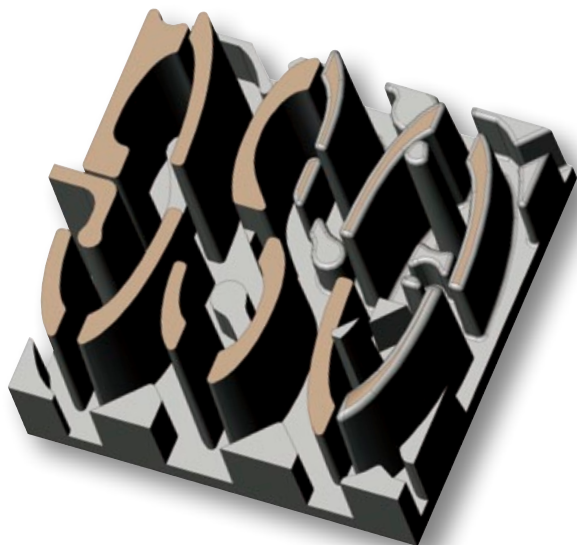

ワーク寸法：80×80×45mm 被削材：SKD61 (50HRC)

Work Size

Work Material

使用機械：3軸加工機

Machine: Three-axis Machining Center

主軸タイプ：HSK A63タイプ

Main Spindle

切削油剤：なし(エアブロー)

Coolant: Air Blow

最高回転数：20,000min⁻¹

Maximum RPM

ホルダ：焼ばめホルダ

Holder: Shrink Fit

工程番号 Process	加工内容 Milling Process	使用工具 Tool	突出し量 Overhang Length	回転速度 (min ⁻¹) Speed	送り速度 (mm/min) Feed	軸方向 切込深さ (mm) ap	径方向 切込深さ (mm) pf	残り代 (mm) Stock to Leave	切削距離 (m) Milling Length	切削時間 Milling Time
1	3D 等高線荒加工 3D Arbitrary Stock Roughing	PHX-DFR φ10×R2	40	1,770	2,000	0.3	3.0	0.2	371	3:39:49
2	等高線中荒加工 Arbitrary Stock Semi-roughing	PHX-LN-DFR φ6×R1.5×30	30	1,700	1,060	0.104	1.5	0.03	67	8:33:40
3	等高線中荒加工 Arbitrary Stock Semi-roughing	PHX-PC-DFR φ3×R0.8×1°×40	45	3,200	680	0.045	0.7	0.03	192	21:07:50
4	等高線中荒加工 Arbitrary Stock Semi-roughing	PHX-PC-DFR φ2×R0.5×1°×40	47	1,830	220	0.014	0.5	0.03	585	23:56:50
5	等高線仕上げ加工 Z-Level Finishing	↓	47	2,320	180	0.1	0.03	0	583	45:05:05

トータル加工時間 102:23:14
Total operation time

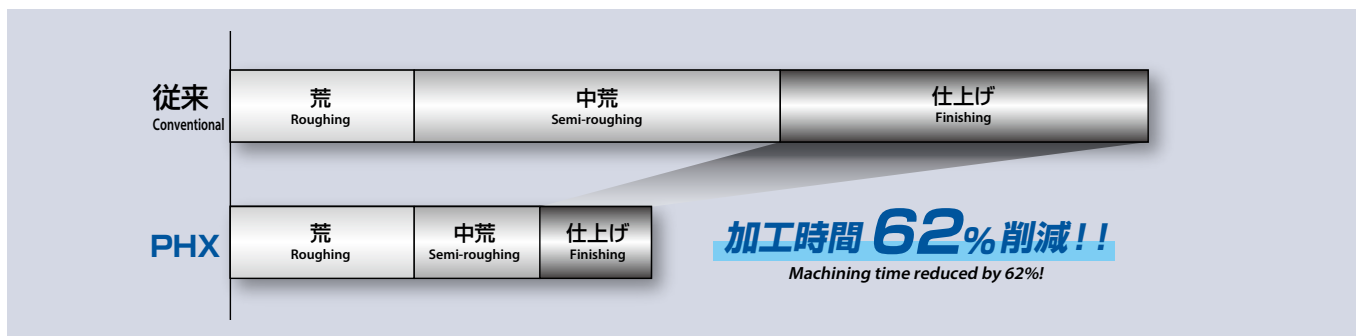

荒加工を時間短縮!

PHXロングネックボール PHX-LN-DBT

Time required for roughing can be greatly reduced with the PHX long neck ball nose end mill!

特長 Features

● 短い刃長 Short length of cut

0.75D の短い刃長で高剛性。
立ち壁加工を低い抵抗で切削します。
Highly rigid 0.75D short length of cut geometry enables
low resistance vertical wall milling.



● 立ち壁加工の精度が向上

Improved accuracy in vertical wall milling

外周刃で立ち壁を
さらうことで、
精度が向上します。
Without back taper, the
PHX-LN-DBT's peripheral
cutting edge is able to
achieve flat milling to improve
accuracy.

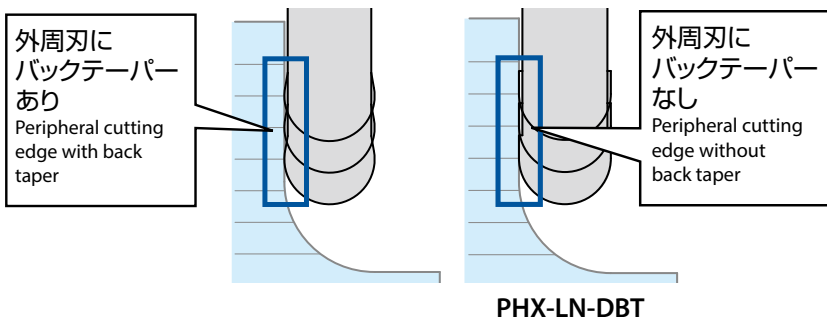

● 首部の形状がスリムに

Slim neck shape

特に、首下長の短い5軸加工などに
効果を発揮します。
Performs particularly well in five-axis milling
with neck length limitation.

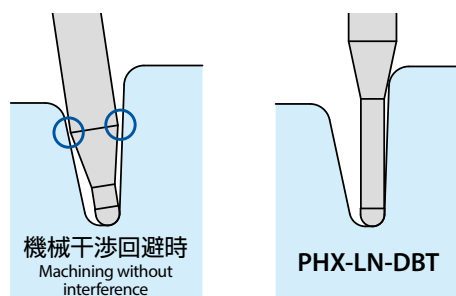

PHX-LN-DBTでの時間短縮事例

Case study on the PHX-LN-DBT's superior processing efficiency

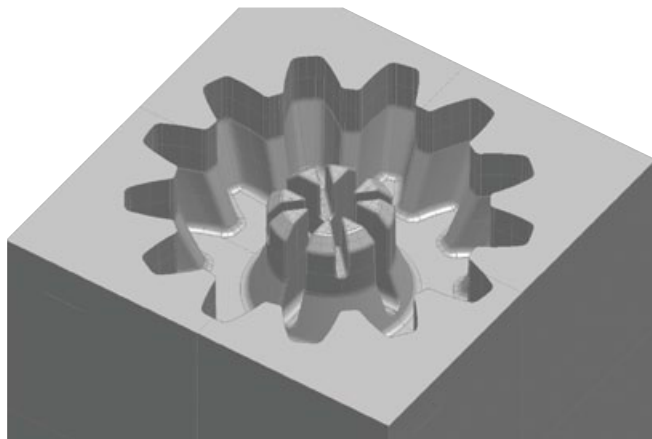

ワーク寸法 : 50×50×50mm 被削材 : NAK80(40HRC)
Work Size Work Material

使用機械 : 5軸加工機 主軸タイプ : HSK A63タイプ 切削油剤 : なし(エアブロー) 最高回転数 : 18,000min⁻¹ ホルダ : 焼ばめホルダ
Machine: Five-axis Machining Center Main Spindle Coolant : Air Blow Maximum RPM Holder : Shrink Fit

OSG JAPAN PHX

加工動画 Watch the PHX in action

YouTube

工程番号 Process	加工内容 Milling Process	使用工具 Tool	突出し量 Overhang Length	回転速度 (min ⁻¹) Speed	送り速度 (mm/min) Feed	軸方向 切込深さ (mm) ap	径方向 切込深さ (mm) pf	残り代 (mm) Stock to Leave	切削距離 (m) Milling Length	切削時間 Milling Time
1	3D 等高線荒加工 3D Arbitrary Stock Roughing	PHX-LN-DBT R3×20	22	8,000	4,500	0.50	1.5	0.1	10.1	0:06:27
2	等高線荒加工 Arbitrary Stock Roughing	PHX-LN-DBT R1×12	20	12,000	1,200	0.15	0.8	0.05	28.3	0:43:19
3※1	3D 等高線最適化加工 3D Complete Machining	↓	20	12,000	1,200	—	0.4	0.05	782.0	
4	3D 等高線仕上げ加工 3D Z-Level Finishing	↓	20	12,000	2,000	0.12	—	0	33.4	
5	3D 走査線仕上げ加工 3D Plofile Finishing	↓	20	12,000	2,000	—	0.12	0	4.4	0:31:31
6	3D 削り残り部加工 3D Rest Machining	↓	20	12,000	2,000	0.12	0.12	0	2.5	0:36:58
7	3D 等高線仕上げ加工 3D Z-Level Finishing	PHX-LN-DBT R0.5×6	15	12,000	600	0.06	—	0	8.3	
8	3D 等高線仕上げ加工 3D Z-Level Finishing	↓	15	12,000	800	0.06	—	0	6.7	
9	3D 走査線仕上げ加工 3D Plofile Finishing	↓	15	12,000	800	—	0.06	0	433.0	

※1 平面部のみ For flat surface milling

トータル加工時間 1:58:15
 Total operation time

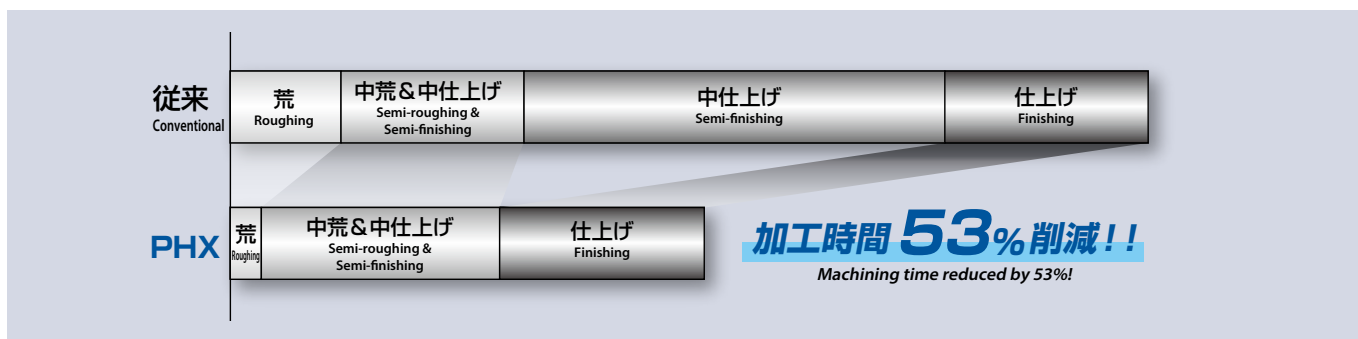

リブ溝加工に

4枚刃小径ロングネックブルノーズ PHX-LN-CRE

4-flute Long Neck Small Bull Nose End Mill

特長 Features

● 切削抵抗と刃先剛性を両立させたコーナR形状

The corner radius shape provides both cutting force and cutting edge rigidity.

● びびり振動を抑える外周刃と底刃仕様

Radial and end edge configurations suppress the generation of chattering vibration.

● 特殊なエッジラインで食い込み防止

Special edge lines prevent biting.

● 最適なチップポケットで優れた切りくず排出性

An ideal chip pocket for superior chip evacuation.

① 短い刃長

Length of cut

② 短い溝の切上げ

Short flute length

③ 不等分割

Unequal spacing

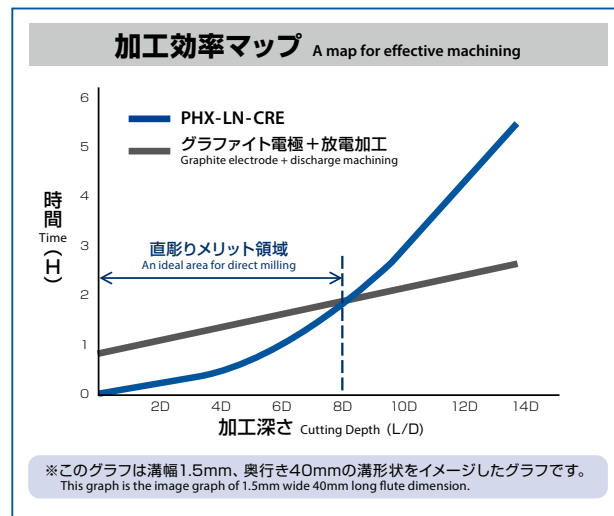
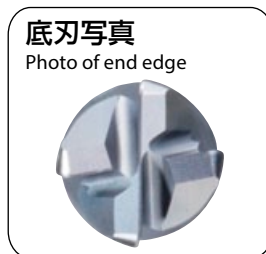
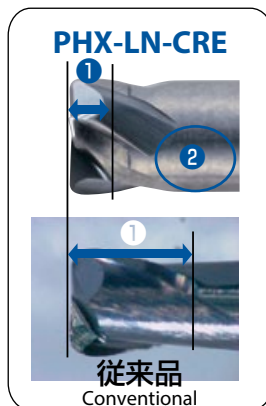

■プラスチック金型でのリブ加工

Lib operation on plastic mold

使用工具 Tool	PHX-LN-CRE $\phi 1 \times R0.2 \times 6$
被削材 Work Material	STAVAX (52HRC)
切削方法 Milling Method	リブ溝加工 Lib Groove Operation
切削速度 Cutting Speed	63m/min (20,000min ⁻¹)
送り速度 Feed	840mm/min (0.0105mm/t)
切込深さ Depth of Cut	$a_p=0.02\text{mm}$
切削油剤 Coolant	なし (エアブロー) Air Blow
使用機械 Machine	立形マシニングセンタ (HSK-E32) Vertical Machining Center
切削長さ Milling Length	120m



高硬度材 STAVAX(52HRC)などをターゲットにした溝加工専用工具が威力を発揮
直彫りを無理なくこなす専用工具！ 特殊刃先形状が安定切削を実現！ 浅溝での超高能率切削も可能！
A special designed tool for slot milling on high hardness steel as STAVAX(52HRC)
A special tool for easy direct milling operations! A special cutting edge design enabled a stable operation! Capable even on shallow flute milling with ultra high speed!

■ギア形状 HPM38(53HRC)で高精度加工

High precision machining on HPM38(53HRC) with gear shape

使用工具 Tool	PHX-LN-CRE $\phi 2 \times R0.5 \times 10$
被削材 Work Material	HPM38 (53HRC)
切削方法 Milling Method	等高線加工 Contour Line Operation
切削速度 Cutting Speed	113m/min (18,000min ⁻¹)
送り速度 Feed	2,500mm/min (0.035mm/t)
切込深さ Depth of Cut	$a_p=0.1\text{mm}$ $a_e=0.8\text{mm}$
切削油剤 Coolant	なし (エアブロー) Air Blow
使用機械 Machine	立形マシニングセンタ (HSK-A63) Vertical Machining Center
切削長さ Milling Length	80m



中荒加工から仕上げまで！ 狭い部分でも高送り加工！
From semi-finish to finishing operation! Capable with high feed rate even at narrow area!

フェニックス ディープフィーダーブルノーズ

Phoenix Deep Feeder Bull Nose End Mill

PHX-DFR

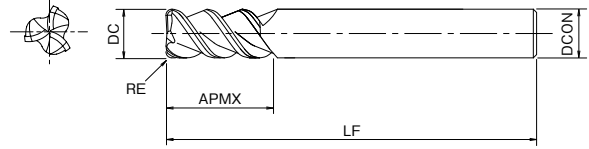

単位:mm Unit:mm

ツールNo. EDP No.	外径×コーナ半径 DC × RE	全長 LF	刃長 APMX	シャンク径 DCON	刃数 ZAFP	在庫 Stock	標準価格 (Yen)
3090512	6 × R1.5	80	12	6	3	B ●	17,900
3090516	8 × R2	90	16	8	3	B ●	23,100
3090520	10 × R2	100	20	10	3	B ●	28,300
3090522	12 × R2	120	24	12	3	B ●	38,500
3090526	16 × R3	130	32	16	3	B ●	79,700
3090530	20 × R3	150	40	20	3	B ●	113,000

●=標準在庫品 ●= Standard stock item

アイコンの種類について Guide for Icons

1 材質 Tool Materials

CARBIDE 超硬合金
Tungsten Carbide

2 表面処理 Surface Treatment

WXS WX スーパーコート
WX Super Coating

FX FX コーティング
FX (TiAlN) Coating

3 ねじれ角 Helix Angle

45° エンドミルの溝の
ねじれ角を表示します
Helix angle of flute for end mills

4 R許容差 Tolerance of Radius

R ±0.07 エンドミルの R 許容差を表示します
Identifies the tolerance of the radius for end mills

5 外径の許容差 Tolerance for milling diameter

○ エンドミルの外径を表示します
Tolerance for milling diameter

6 シュリンク Shrink

SHRINK FIT シュリンクフィット (焼きばめ)
システムにもお奨めします
Suitable for the shrink holder system

7 切削条件 Cutting Conditions

SPEED FEED 切削条件基準表掲載ページを
表示します
Indicates page number for cutting conditions



フェニックス ペンシルネックディープフィーダーブルノーズ

Phoenix Pencil Neck Deep Feeder Bull Nose End Mill

PHX-PC-DFR

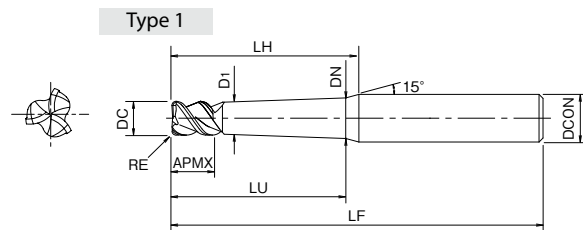

Type 2

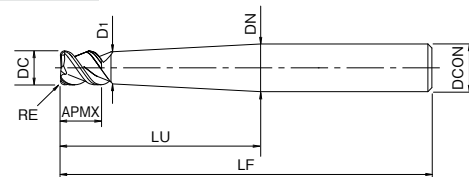

0~0.015

単位:mm Unit:mm

ツールNo. EDP No.	有効勾配角 α	外径×コーナ半径×首部テーパー半角×首下長 DC × RE × θ_n × LU	LH	全長 LF	刃長 APMX	シャンク径 DCON	首径 D _i	首元径 DN	干渉角度 θ_k	ワーク勾配角 α に対する実有効長 (Le) 注1					刃数 Z/EFP	形状 Type	在庫 Stock	標準価格 (Yen)
										0.5°	1°	1.5°	2°	3°				
3097222	0.29°	2 × R0.5 × 0.5° × 15	22.9	60	3	6	1.95	2.15	5.16°	15.21	15.74	16.31	16.92	18.29	3	1	●	14,900
3097223	0.36°	2 × R0.5 × 0.5° × 20	27.7							2.25	4.24°	20.19	20.89	21.64				
3097224	0.39°	2 × R0.5 × 0.5° × 25	32.6	70	3	6	1.95	2.33	3.6°	25.2	26.08	27.02	28.03	30.31	3	1	●	15,600
3097225	0.41°	2 × R0.5 × 0.5° × 30	37.4							2.42	3.13°	30.19	31.25	32.38				
3097226	0.42°	2 × R0.5 × 0.5° × 35	42.2	80	3	6	1.95	2.51	2.76°	35.19	36.42	37.73	39.15	—	3	1	●	17,300
3097227	0.43°	2 × R0.5 × 0.5° × 40	47.1							2.6	2.48°	40.18	41.58	43.09				
3097241	0.59°	2 × R0.5 × 1° × 10	17.8	60	3	6	1.95	2.19	6.67°	9.08	10.31	10.69	11.09	11.99	3	1	●	14,600
3097242	0.73°	2 × R0.5 × 1° × 15	22.5							2.37	5.25°	8.83	15.3	15.85				
3097243	0.8°	2 × R0.5 × 1° × 20	27.1	70	3	6	1.95	2.54	4.33°	8.93	20.31	21.04	21.83	23.61	3	1	●	15,200
3097244	0.84°	2 × R0.5 × 1° × 25	31.8							2.72	3.68°	8.83	25.3	26.21				
3097245	0.87°	2 × R0.5 × 1° × 30	36.5	80	3	6	1.95	2.89	3.2°	8.9	30.31	31.4	32.58	35.22	3	1	●	15,900
3097246	0.89°	2 × R0.5 × 1° × 35	41.2							3.07	2.83°	8.83	35.3	36.57				
3097247	0.9°	2 × R0.5 × 1° × 40	45.8	100	3	6	1.95	3.24	2.54°	8.88	40.31	41.76	43.33	—	3	1	●	17,600
3097248	0.91°	2 × R0.5 × 1° × 45	50.5							3.42	2.3°	8.83	45.3	46.93				
3097249	0.92°	2 × R0.5 × 1° × 50	55.2	110	3	6	1.95	3.59	2.11°	8.87	50.31	52.12	54.08	—	3	1	●	19,300
3097250	0.92°	2 × R0.5 × 1° × 60	64.6							3.92	1.8°	8.98	60.34	62.52				
3097251	1.37°	2 × R0.5 × 1.5° × 40	44.6	80	3	6	1.95	3.89	2.61°	5.93	11.83	40.42	41.93	—	3	1	●	17,600
3097252	1.4°	2 × R0.5 × 1.5° × 60	62.8							4.91	1.85°	5.97	12.09	60.48				
3097253	1.41°	2 × R0.5 × 1.5° × 81.6	—	120	3	6	1.95	6	1.41°	6	12.31	—	—	3	2	●	25,600	
3097262	1.92°	2 × R0.5 × 2° × 60.3	—							100	1.9°	4.92	7.33					14.31
3097263	1.91°	2 × R0.5 × 2° × 80	82.1	120	3	6	1.95	7.29	2.12°	4.97	7.49	15.2	80.63	3	1	●	25,600	
3097273	2.81°	2 × R0.5 × 3° × 41.2	—							100	6	6	2.78°					4.16

・アイコンの説明はp.9をご覧ください。 See p.9 for explanation of icons.

●=標準在庫品 ●= Standard stock item

注1: ワーク勾配角 α に対する実有効長 (Le)

Effective neck length (Le) based on the inclination angle (α) of workpiece.

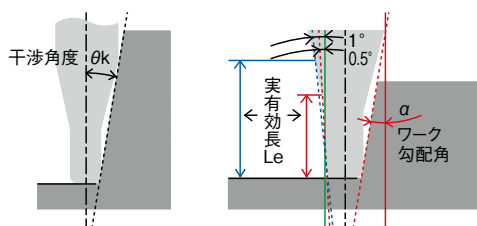

実有効長欄に数値のないものは干渉なしを表します。
No numerical value means no interference with the workpiece.

NEXT



フェニックス ペンシルネックディープフィーダーブルノーズ

Phoenix Pencil Neck Deep Feeder Bull Nose End Mill

PHX-PC-DFR

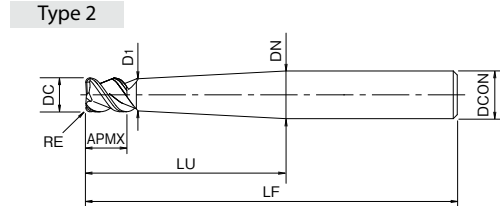
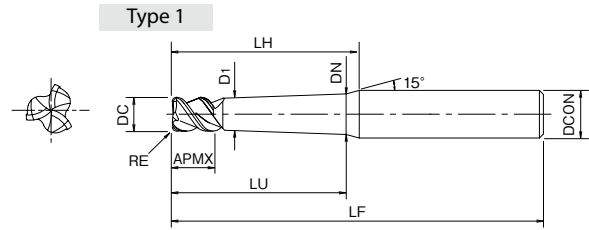

CARBIDE
WXS
R ±0.03
SHRINK FIT
55°
SPEED FEED P29-32

0~0.015

FROM

単位:mm Unit:mm

ツールNo. EDP No.	有効勾配角 α	外径×コーナ半径×首部テーパ半角×首下長 DC × RE × θn × LU	LH	全長 LF	刃長 APMX	シャンク径 DCON	首径 Di	首元径 DN	干渉角度 θk	ワーク勾配角αに対する実有効長(Le)注1					刃数 ZEPF	形状 Type	在庫 Stock	標準価格 (Yen)							
										0.5°	1°	1.5°	2°	3°											
3097281	0.46°	2.5 × R0.8 × 0.75° × 16	22.8	70	3.8	6	2.45	2.74	4.54°	16.07	16.63	17.23	17.88	19.33	3	1	B	● 15,700							
3097282	0.52°	2.5 × R0.8 × 0.75° × 20	26.6					2.85	3.87°	19.87	20.69	21.44	22.24	24.05				● 16,000							
3097283	0.56°	2.5 × R0.8 × 0.75° × 24	30.4					2.95	3.38°	19.74	24.77	25.66	26.63	28.79				● 16,200							
3097284	0.6°	2.5 × R0.8 × 0.75° × 30	36.1					3.11	2.84°	18.83	30.87	31.98	33.18	—				● 16,800							
3097285	0.64°	2.5 × R0.8 × 0.75° × 40	45.6					3.37	2.24°	18.41	41.05	42.53	44.12	—				● 17,400							
3097286	0.66°	2.5 × R0.8 × 0.75° × 50	55.1					3.63	1.85°	18.18	51.22	53.07	—	—				● 18,700							
3097291	1.01°	2.5 × R0.8 × 1.5° × 16	22.3	100	4.5	6	2.9	3.04	4.65°	7.56	16.03	16.61	17.23	18.63	3	1	B	● 15,700							
3097292	1.11°	2.5 × R0.8 × 1.5° × 20	25.9					3.25	3.99°	7.44	16.42	20.61	21.38	23.12				● 16,000							
3097293	1.18°	2.5 × R0.8 × 1.5° × 24	29.5					3.46	3.49°	7.37	15.9	24.61	25.53	27.6				● 16,200							
3097294	1.25°	2.5 × R0.8 × 1.5° × 30	34.9					3.77	2.94°	7.33	15.61	30.62	31.77	—				● 16,800							
3097295	1.31°	2.5 × R0.8 × 1.5° × 40	43.9					4.3	2.33°	7.26	15.08	40.6	42.13	—				● 17,400							
3097296	1.35°	2.5 × R0.8 × 1.5° × 50	52.9					4.82	1.93°	7.24	14.95	50.61	—	—				● 18,700							
3097297	1.38°	2.5 × R0.8 × 1.5° × 60	62					5.34	1.64°	7.22	14.86	60.62	—	—				● 19,200							
3097314	0.79°	3 × R0.5 × 1° × 40	44.3					80	8	6	2.9	4.09	1.98°	15.61				40.61	42.07	—	—	3	1	B	● 15,800
3097316	0.86°	3 × R0.5 × 1° × 60	63									4.79	1.39°	15.26				60.6	—	—	—				● 17,700
3097321	0.25°	3 × R0.8 × 0.5° × 20	26									3.17	3.4°	20.34				21.05	21.81	22.63	24.46				● 15,000
3097324	0.36°	3 × R0.8 × 0.5° × 40	45.4									3.5	1.93°	40.38				41.78	43.29	—	—				● 15,800
3097341	0.66°	3 × R0.8 × 1° × 20	25.5									3.44	3.47°	14.77				20.51	21.25	22.05	23.84				● 15,000
3097342	0.73°	3 × R0.8 × 1° × 25	30.1	3.62	2.92°	14.61	25.5					26.42	27.41	—	● 15,200										
3097343	0.78°	3 × R0.8 × 1° × 30	34.8	3.79	2.52°	14.73	30.51					31.61	32.8	—	● 15,500										
3097344	0.83°	3 × R0.8 × 1° × 40	44.2	4.14	1.98°	14.72	40.51					41.97	—	—	● 15,800										
3097345	0.87°	3 × R0.8 × 1° × 50	53.5	4.49	1.63°	14.71	50.51					52.33	—	—	● 17,300										
3097346	0.89°	3 × R0.8 × 1° × 60	62.9	4.84	1.39°	14.7	60.5					—	—	—	● 17,700										
3097347	0.9°	3 × R0.8 × 1° × 80	81.4	5.48	1.07°	15.18	80.62					—	—	—	● 18,500										
3097348	0.92°	3 × R0.8 × 1° × 100	104.1	6.19	1.39°	15	100.6					—	—	—	● 25,700										
3097356	1.43°	3 × R0.8 × 1.5° × 60.8	—	100	6	8	6					1.42°	9.25	17.26	—	—	—	2	1	B	● 17,700				
3097365	1.88°	3 × R0.8 × 2° × 46.5	—									1.85°	7.67	11.11	20.16	—	—				—				● 17,200
3097368	1.81°	3 × R0.8 × 2° × 80	—									8	1.79°	8.06	12.38	26.62	—				—				● 25,700
3097374	2.74°	3 × R0.8 × 3° × 32.1	—	100	6	6	2.68°					6.38	7.82	10.1	14.25	—	—	—	—	● 16,600					

・アイコンの説明はp.9をご覧ください。 See p.9 for explanation of icons.

●=標準在庫品 ●= Standard stock item

NEXT



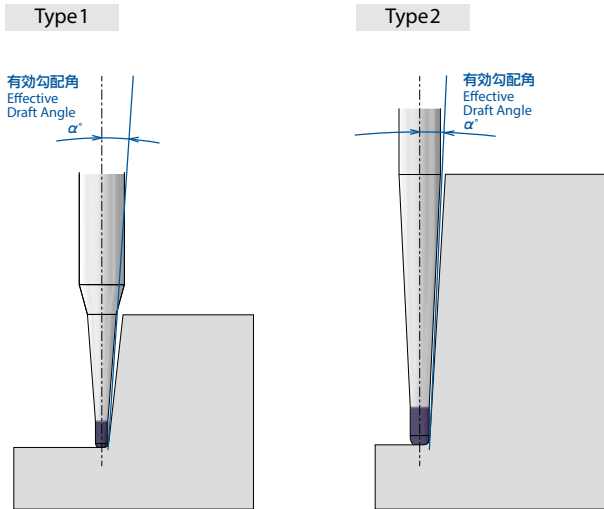

※切削状態によっては、工具がたわみ、勾配部が干渉する場合があります。

The tool may be deflected and may interfere with the draft area depending on milling condition.

※首部テーパ半角 (θn°) は便宜上有効勾配角 (α°) と同表記していますが、実際には異なります。(有効勾配角 (α°) に干渉しない角度にて設定)

For convenience, the draft angle (θn°) is illustrated the same as the effective draft angle (α°), but they are not identical. The effective draft angle (α°) is configured without interference.

FROM

単位 :mm Unit:mm

ツールNo. EDP No.	有効勾配角 α	外径×コーナ半径×首部テーパ半角×首下長 DC × RE × θn × LU	LH	全長 LF	刃長 APMX	シャンク径 DCON	首径 D _i	首元径 DN	干渉角度 θk	ワーク勾配角 α に対する実有効長 (Le) 注1					刃数 ZAFP	形状 Type	在庫 Stock	標準価格 (Yen)
										0.5°	1°	1.5°	2°	3°				
3097401	0.67°	4 × R0.5 × 1° × 30	33.1	80				4.69	1.77°	19.24	30.71	31.82				●	15,700	
3097402	0.83°	4 × R0.5 × 1° × 60	60.9	100				5.73	0.95°	18.46	—	—				●	17,700	
3097421	0.28°	4 × R1 × 0.5° × 25	29					4.23	2.03°	25.39	26.28	27.23	28.25			●	15,500	
3097422	0.31°	4 × R1 × 0.5° × 30	33.9					4.32	1.73°	30.39	31.45	32.58				●	15,700	
3097423	0.34°	4 × R1 × 0.5° × 35	38.7	80				4.41	1.51°	35.38	36.62	37.94				●	15,800	
3097424	0.36°	4 × R1 × 0.5° × 40	43.5					4.49	1.34°	40.4	41.8				1	●	16,000	
3097425	0.38°	4 × R1 × 0.5° × 45	48.4					4.58	1.21°	45.39	46.97	—				●	16,100	
3097426	0.39°	4 × R1 × 0.5° × 50	53.2	100				4.67	1.1°	50.39	52.14					●	17,400	
3097441	0.73°	4 × R1 × 1° × 30	33	80				4.74	1.78°	—	30.61	31.71				●	15,700	
3097442	0.8°	4 × R1 × 1° × 40	42.4		6		3.9	5.09	1.38°	17.67	40.61			3	B	●	16,000	
3097443	0.84°	4 × R1 × 1° × 50	51.8	100				5.44	1.13°	—	50.6					●	17,400	
3097444	0.95°	4 × R1 × 1° × 61.3	—					6	0.94°	15.98	—	—			2	●	17,800	
3097445	0.88°	4 × R1 × 1° × 80	83.6	120		8		6.44	1.39°	18.13	80.7				1	●	25,700	
3097453	1.39°	4 × R1 × 1.5° × 42.2	—	80		6		6	1.36°	11.05	19.4				2	●	16,000	
3097454	1.44°	4 × R1 × 1.5° × 80.4	—	120		8		8	1.43°	11.44	21.32					●	25,700	
3097455	1.38°	4 × R1 × 1.5° × 100	103	150		10		8.76	1.68°	11.98	24.43	100.98				●	31,100	
3097456	1.39°	4 × R1 × 1.5° × 120	120.8	160		10		9.78	1.43°	12	24.57	—				●	37,400	
3097461	1.81°	4 × R1 × 2° × 32.6	—	80		6		6	1.76°	9.33	13.03	21.59				●	15,800	
3097462	1.9°	4 × R1 × 2° × 61.3	—	120		8		8	1.87°	9.61	13.89	25.03				●	24,000	
3097472	2.78°	4 × R1 × 3° × 42.2	—	100		8		8	2.72°	8.14	9.95	12.8	17.95			●	20,900	

注1: ワーク勾配角 α に対する実有効長 (Le)
Effective neck length (Le) based on the inclination angle (α) of workpiece.

● = 標準在庫品 ● = Standard stock item

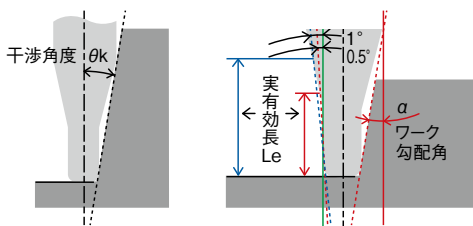

実有効長欄に数値のないものは干渉なしを表します。
No numerical value means no interference with the workpiece.

NEXT



フェニックス ペンシルネックディープフィーダーブルノーズ

Phoenix Pencil Neck Deep Feeder Bull Nose End Mill

PHX-PC-DFR



Type 1

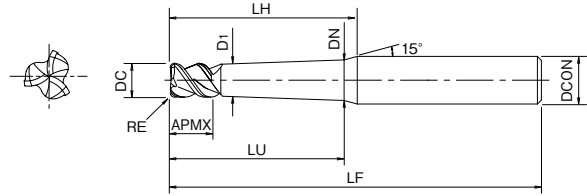

Type 2

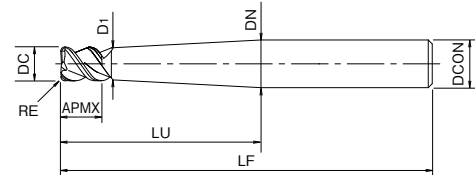

CARBIDE **WXS** ± 0.03 R **SHRINK FIT** 55° **SPEED FEED P29-32**
 0~0.015

FROM

単位:mm Unit:mm

ツールNo. EDP No.	有効勾配角 α	外径×コーナ半径×首部テーパ(半角)×首下長 DC × RE × θ_n × LU	LH	全長 LF	刃長 APMX	シャンク径 DCON	首径 D _i	首元径 D _N	干渉角度 θ_k	ワーク勾配角 α に対する実有効長(Le) ^{注1}					刃数 ZEPF	形状 Type	在庫 Stock	標準価格 (Yen)
										0.5°	1°	1.5°	2°	3°				
3097602	0.93°	6 × R0.8 × 1° × 62.3	—	130	—	8	—	8	0.92°	20.71	—	—	—	—	2	●	23,500	
3097603	0.89°	6 × R0.8 × 1° × 120	120.9	160	—	10	—	9.72	0.96°	24.16	—	—	—	—	—	●	33,100	
3097627	0.39°	6 × R1.5 × 0.5° × 60	63	130	—	—	—	6.79	0.93°	60.49	—	—	—	—	1	●	23,500	
3097641	0.73°	6 × R1.5 × 1° × 40	42.6	—	—	8	—	6.98	1.37°	23.79	40.83	—	—	—	—	●	20,100	
3097642	0.79°	6 × R1.5 × 1° × 50	51.9	—	—	—	—	7.33	1.12°	23.75	50.82	—	—	—	—	●	20,800	
3097643	0.94°	6 × R1.5 × 1° × 62.3	—	130	—	—	—	8	0.92°	20.71	—	—	—	—	2	●	23,500	
3097644	0.85°	6 × R1.5 × 1° × 80	83.8	120	—	9	5.9	8.33	1.38°	24.33	80.92	—	—	—	3	●	26,300	
3097645	0.88°	6 × R1.5 × 1° × 100	102.5	150	—	10	—	9.03	1.13°	24.17	100.92	—	—	—	1	●	29,500	
3097646	0.9°	6 × R1.5 × 1° × 120	120.9	160	—	—	—	9.72	0.96°	24.16	—	—	—	—	—	●	33,100	
3097651	1.37°	6 × R1.5 × 1.5° × 43.2	—	100	—	8	—	8	1.33°	14.85	24.63	—	—	—	2	●	20,300	
3097653	1.43°	6 × R1.5 × 1.5° × 81.4	—	130	—	10	—	10	1.41°	15.56	28.07	—	—	—	—	●	30,000	
3097654	1.36°	6 × R1.5 × 1.5° × 120	121.1	160	—	12	—	11.63	1.43°	16.52	33.78	—	—	—	1	●	37,400	
3097661	1.78°	6 × R1.5 × 2° × 33.6	—	100	—	8	—	8	1.71°	12.79	17.21	26.32	—	—	—	●	19,800	
3097662	1.88°	6 × R1.5 × 2° × 62.3	—	130	—	10	—	10	1.84°	13.32	18.86	32.27	—	—	—	●	28,600	
3097814	0.92°	8 × R1 × 1° × 63.3	—	120	—	10	—	10	0.91°	25.18	—	—	—	—	2	●	30,500	
3097817	0.96°	8 × R1 × 1° × 120.6	—	180	—	12	—	12	0.96°	27.24	—	—	—	—	—	●	47,100	
3097826	0.4°	8 × R2 × 0.5° × 80	82.6	150	—	—	—	9.09	0.71°	80.59	—	—	—	—	1	●	31,100	
3097841	0.73°	8 × R2 × 1° × 50	52.3	120	—	10	—	9.23	1.12°	29.64	51.02	—	—	—	—	●	26,800	
3097842	0.93°	8 × R2 × 1° × 63.3	—	150	—	—	—	10	0.91°	25.18	—	—	—	—	—	●	30,500	
3097844	0.97°	8 × R2 × 1° × 120.6	—	180	—	12	—	12	0.96°	27.24	—	—	—	—	—	●	47,100	
3097851	1.36°	8 × R2 × 1.5° × 44.2	—	120	—	10	7.9	10	1.3°	18.48	29.12	—	—	—	2	●	26,700	
3097853	1.42°	8 × R2 × 1.5° × 82.4	—	150	—	12	—	12	1.4°	19.59	34.24	—	—	—	—	●	39,600	
3097855	1.33°	8 × R2 × 1.5° × 120	125.4	160	—	—	—	13.49	1.84°	21.02	42.8	121.64	—	—	1	●	69,500	
3097856	1.37°	8 × R2 × 1.5° × 160	161.3	200	—	16	—	15.57	1.43°	21	42.68	—	—	—	—	●	84,000	
3097861	1.76°	8 × R2 × 2° × 34.6	—	—	—	10	—	10	1.66°	16.1	20.95	29.97	—	—	—	●	26,200	
3097862	1.87°	8 × R2 × 2° × 63.3	—	120	—	12	—	12	1.81°	16.95	23.53	38.44	—	—	2	●	34,000	

・アイコンの説明はp.9をご覧ください。See p.9 for explanation of icons.

●=標準在庫品 ●= Standard stock item



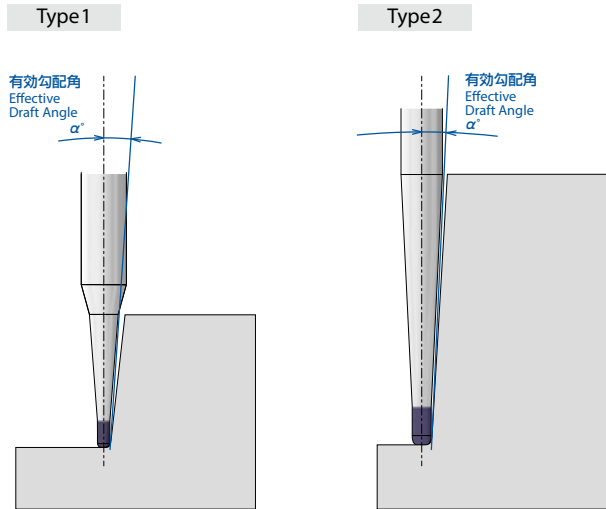

※切削状態によっては、工具がたわみ、勾配部が干渉する場合があります。

The tool may be deflected and may interfere with the draft area depending on milling condition.

※首部テーパ半角 (θ_n°) は便宜上有効勾配角 (α°) と同表記していますが、実際には異なります。(有効勾配角 (α°) に干渉しない角度にて設定)

For convenience, the draft angle (θ_n°) is illustrated the same as the effective draft angle (α°), but they are not identical. The effective draft angle (α°) is configured without interference.

FROM

単位 :mm Unit:mm

ツールNo. EDP No.	有効勾配角 α	外径×コーナ半径×首部テーパ半角×首下長 DC × RE × θ_n × LU	LH	全長 LF	刃長 APMX	シャンク径 DCON	首径 D _i	首元径 DN	干渉角度 θ_k	ワーク勾配角 α に対する実有効長 (Le) 注1					刃数 Z/EFP	形状 Type	在庫 Stock	標準価格 (Yen)				
										0.5°	1°	1.5°	2°	3°								
3098026	0.4°	10 × R2 × 0.5° × 100	102	150	12	9.9	11.38	0.57°	100.7	—	—	—	—	1	B	●	39,300					
3098041	0.92°	10 × R2 × 1° × 64.3	—	120					12	0.9°	29.39	—	—			—	—	—	2	●	33,200	
3098042	0.8°	10 × R2 × 1° × 80	88	160					16	9.9	12.17	1.98°	35.71	81.24	84.17	—	1	B	●	59,100		
3098043	0.84°	10 × R2 × 1° × 100	106.7									12.87	1.63°	35.69	101.23	104.89			—	—	—	—
3098044	0.87°	10 × R2 × 1° × 120	125.4	180								13.57	1.38°	35.68	121.23	—	—	—	—	1	●	69,500
3098045	0.88°	10 × R2 × 1° × 140	144.1	200								14.26	1.2°	35.76	141.25	—	—	—	—	3	●	77,000
3098046	0.9°	10 × R2 × 1° × 160	162.7	220								14.96	1.07°	35.74	161.24	—	—	—	—	3	●	84,000
3098051	1.33°	10 × R2 × 1.5° × 45.2	—	120								12	1.27°	21.95	33.01	—	—	—	—	2	●	32,000
3098052	1.19°	10 × R2 × 1.5° × 80	85.9	140								16	2.02°	25.66	52.86	81.96	85.03	—	—	1	●	58,900
3098053	1.44°	10 × R2 × 1.5° × 121.6	—	180								16	1.42°	24.1	42.95	—	—	—	—	1	●	70,000
3098061	1.7°	10 × R2 × 2° × 35.6	—	120								12	1.61°	19.28	24.3	32.87	—	—	—	2	●	31,500
3098064	1.89°	10 × R2 × 2° × 92.9	—	220								16	1.85°	20.95	29.37	49.15	—	—	—	2	●	73,300
3098224	0.41°	12 × R2 × 0.5° × 120	125.2	180	18	11.9	13.68	0.93°				120.79	—	—	—	1	B	●	69,800			
3098241	0.67°	12 × R2 × 1° × 60	65.8	120				16				1.77°	41.6	61.44	63.66			—	—	—	1	●
3098242	0.81°	12 × R2 × 1° × 100	103.2	180				16	1.12°	41.77	101.45	—	—	—	—	3	●	67,100				
3098243	0.95°	12 × R2 × 1° × 122.6	—					16	0.94°	37.05	—	—	—	—	—	2	●	70,100				
3098244	0.88°	12 × R2 × 1° × 160	166.7	220				20	1.39°	41.7	161.44	—	—	—	—	1	●	115,000				
3098254	1.44°	12 × R2 × 1.5° × 160.8	—					20	1.43°	28.55	51.39	—	—	—	—	2	●	115,000				

注 1: ワーク勾配角 α に対する実有効長 (Le)
Effective neck length (Le) based on the inclination angle (α) of workpiece.

● = 標準在庫品 ● = Standard stock item

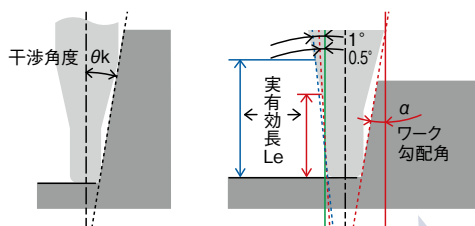

実有効長欄に数値のないものは干渉なしを表します。
No numerical value means no interference with the workpiece.



フェニックス ロングネックディープフィーダーブルノーズ

Phoenix Long Neck Deep Feeder Bull Nose End Mill

PHX-LN-DFR

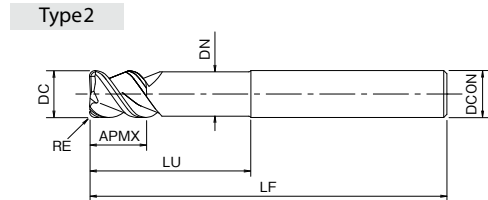
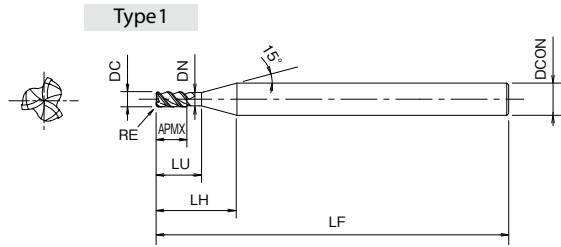

CARBIDE
WXS
R ±0.03
±0.01
SHRINK FIT
55°
SPEED FEED P29-32

単位:mm Unit:mm

ツールNo. EDP No.	外径×コーナ半径×首下長・シャンク径 DC × RE × LU - DCON	LH	全長 LF	刃長 APMX	シャンク径 DCON	首径 DN	干渉角度 θk	ワーク勾配角αに対する実有効長(Le) ^{注1}					刃数 ZEPF	形状 Type	在庫 Stock	標準価格 (Yen)	
								0.5°	1°	1.5°	2°	3°					
3091021	2 × R0.5 × 16	24	50	3	6	1.89	4.83°	16.75	17.33	17.96	18.63	20.14	3	1	B	● 14,200	
3091022	2 × R0.5 × 20	28	60				4.14°	20.88	21.61	22.39	23.23	25.11				● 14,500	
3091023	2 × R0.5 × 24	32	60				3.62°	25.02	25.89	26.82	27.83	30.09				● 14,800	
3091031	3 × R0.8 × 16	22	50	4	6	2.85	3.93°	16.82	17.41	18.04	18.71	20.23	3	1	B	● 14,200	
3091032	3 × R0.8 × 20	26	60				3.32°	20.96	21.69	22.47	23.31	25.21				● 14,500	
3091033	3 × R0.8 × 24	30	70				2.88°	25.09	25.97	26.9	27.91	—				● 14,800	
3091034	3 × R0.8 × 28	34					2.54°	29.23	30.25	31.34	32.51	—				● 15,000	
3091035	3 × R0.8 × 32	38					3.44°	33.36	34.52	35.77	37.11	40.12				● 15,400	
3091040	4 × R1 × 16	20.1	50	6	6	3.8	4.8°	16.92	17.51	18.14	18.82	20.35	3	1	B	● 14,200	
3092041	4 × R1 × 20	—	70				—	—	—	—	—	—				—	● 13,900
3091043	4 × R1 × 20 - 6	24.1					5.43°	21.05	21.79	22.57	23.42	25.32				● 14,500	
3091044	4 × R1 × 24	28.1					4.83°	25.19	26.07	27.01	28.02	30.29				● 14,800	
3092042	4 × R1 × 28	—	90				—	—	—	—	—	—				—	● 14,100
3091045	4 × R1 × 28 - 6	32.1					4.34°	29.32	30.35	31.44	32.62	35.27				● 15,000	
3091046	4 × R1 × 32	36.1					3.94°	33.46	34.62	35.87	37.22	40.24				● 15,400	
3091047	4 × R1 × 36	40.1	90				3.61°	37.59	38.9	40.31	41.82	45.21				● 16,000	
3091048	4 × R1 × 40	44.1					3.33°	41.73	43.18	44.74	46.42	50.18				● 16,300	
3091051	5 × R1 × 20	22.2	70	7.5	6	4.8	1.29°	21.05	21.79	—	—	—	3	1	B	● 15,200	
3091052	5 × R1 × 30	32.2					0.89°	31.39	—	—	—	—				● 15,600	
3091053	5 × R1 × 40	42.2					0.68°	41.73	—	—	—	—				● 16,300	

・アイコンの説明はp.9をご覧ください。 See p.9 for explanation of icons.

●=標準在庫品 ●= Standard stock item

注1: ワーク勾配角αに対する実有効長(Le)

Effective neck length (Le) based on the inclination angle (α) of workpiece.

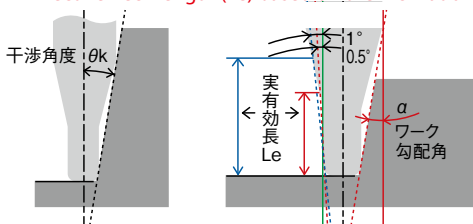

実有効長欄に数値のないものは干渉なしを表します。

No numerical value means no interference with the workpiece.

NEXT



FROM

単位 :mm Unit:mm

ツールNo. EDP No.	外径×コーナ半径×首下長・シャンク径 DC × RE × LU - DCON	LH	全長 LF	刃長 APMX	シャンク径 DCON	首径 DN	干渉角度 θk	ワーク勾配角αに対する実有効長(Le)注1					刃数 ZEFP	形状 Type	在庫 Stock	標準価格 (Yen)	
								0.5°	1°	1.5°	2°	3°					
3091064	6 × R1 × 20	—	70	9	6	5.8	—	—	—	—	—	—	3	2	B	●	15,000
3091065	6 × R1 × 40		90													●	16,800
3091066	6 × R1.5 × 20		70													●	15,000
3092061	6 × R1.5 × 30		80													●	16,000
3092062	6 × R1.5 × 42		90													●	16,800
3092063	6 × R1.5 × 54		100													●	17,700
3091067	6 × R1.5 × 66		110													●	18,700
3092081	8 × R2 × 40	—	85	12	8	7.7	—	—	—	—	—	—	3	2	B	●	20,100
3092082	8 × R2 × 56		100													●	21,900
3092083	8 × R2 × 72		120													●	23,800
3091100	10 × R2 × 30	—	80	15	10	9.7	—	—	—	—	—	—	3	2	B	●	20,400
3091104	10 × R2 × 40		90													●	22,700
3092101	10 × R2 × 50		100													●	25,200
3091105	10 × R2 × 60		110													●	26,300
3092102	10 × R2 × 70		120													●	27,900
3091106	10 × R2 × 80		130													●	29,200
3092103	10 × R2 × 90		140													●	30,500
3091107	10 × R2 × 100	150	●	31,800													
3091120	12 × R2 × 40	—	90	18	12	11.7	—	—	—	—	—	—	3	2	B	●	30,800
3092121	12 × R2 × 60		110													●	34,800
3092122	12 × R2 × 84		135													●	39,100
3092123	12 × R2 × 108		160													●	43,400
3091126	12 × R2 × 120		170													●	47,600
3092161	16 × R3 × 80		140													●	69,800
3092162	16 × R3 × 120	175	●	79,200													

●=標準在庫品 ●= Standard stock item



フェニックス 小径ロングネックブルノーズ

4-flute Long Neck Small Bull Nose End Mill

PHX-LN-CRE

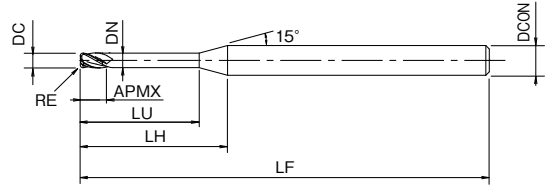

CARBIDE **WXS** ± 0.007 **R** **SHRINK FIT** **54°** **30°** **SPEED FEED P33**
 0~0.015 DC=0.8 1 ≧ DC

首下長許容差：0 ~ 0.1mm
Neck Length Tolerance

単位:mm Unit:mm

ツールNo. EDP No.	外径×コーナ半径×首下長 DC×RE×LU	LH	全長 LF	刃長 APMX	シャンク径 DCON	首径 DN	干渉角度 θ _k	ワーク勾配角αに対する実有効長 (Le) ^{注1}					刃数 ZFP	在庫 Stock	標準価格 (Yen)	
								0.5°	1°	1.5°	2°	3°				
3190800	0.8 × R0.1 × 2	8.1	50	0.32	4	0.72	11.15°	2.22	2.29	2.38	2.47	2.67	4	A	●	7,440
3190801	0.8 × R0.1 × 4	10.1					8.99°	4.28	4.43	4.59	4.77	5.15			●	7,230
3190802	0.8 × R0.1 × 6	12.1					7.52°	6.35	6.57	6.81	7.07	7.64			●	7,230
3190803	0.8 × R0.1 × 8	14.1					6.47°	8.42	8.71	9.03	9.37	10.13			●	7,230
3191006	1 × R0.1 × 4	9.7	50	0.4	4	0.93	8.77°	4.26	4.41	4.57	4.74	5.13	4	A	●	6,230
3191007	1 × R0.1 × 6	11.7					7.29°	6.33	6.55	6.79	7.04	7.62			●	6,840
3191008	1 × R0.1 × 8	13.7					6.24°	8.4	8.69	9.01	9.34	10.1			●	6,840
3191009	1 × R0.1 × 10	15.7					5.45°	10.47	10.83	11.22	11.64	12.59			●	6,840
3191010	1 × R0.1 × 12	17.7					4.84°	12.53	12.97	13.44	13.94	15.08			●	6,840
3191011	1 × R0.2 × 4	9.7					8.77°	4.26	4.41	4.57	4.74	5.13			●	6,230
3191012	1 × R0.2 × 6	11.7					7.29°	6.33	6.55	6.79	7.04	7.62			●	6,840
3191013	1 × R0.2 × 8	13.7					6.24°	8.4	8.69	9.01	9.34	10.1			●	6,840
3191014	1 × R0.2 × 10	15.7					5.45°	10.47	10.83	11.22	11.64	12.59			●	6,840
3191015	1 × R0.2 × 12	17.7					4.84°	12.53	12.97	13.44	13.94	15.08			●	6,840
3191018	1 × R0.3 × 4	9.7					8.77°	4.26	4.41	4.57	4.74	5.13			●	6,230
3191019	1 × R0.3 × 6	11.7					7.29°	6.33	6.55	6.79	7.04	7.62			●	6,840
3191501	1.5 × R0.1 × 4	8.8	50	0.6	4	1.41	8.06°	4.3	4.45	4.61	4.79	5.18	4	A	●	6,640
3191503	1.5 × R0.1 × 8	12.8					5.57°	8.44	8.73	9.05	9.39	10.15			●	7,010
3191505	1.5 × R0.1 × 12	16.8					4.25°	12.57	13.01	13.48	13.99	15.12			●	7,010
3191506	1.5 × R0.2 × 4	8.8					8.06°	4.3	4.45	4.61	4.79	5.18			●	6,640
3191507	1.5 × R0.2 × 6	10.8					6.59°	6.37	6.59	6.83	7.09	7.66			●	6,640
3191508	1.5 × R0.2 × 8	12.8					5.57°	8.44	8.73	9.05	9.39	10.15			●	7,010
3192001	2 × R0.1 × 8	12.1	50	0.8	4	1.89	4.79°	8.48	8.77	9.09	9.43	10.2	4	A	●	7,010
3192002	2 × R0.1 × 10	14.1					4.11°	10.54	10.91	11.31	11.73	12.68			●	7,010
3192003	2 × R0.1 × 12	16.1					3.6°	12.61	13.05	13.52	14.03	15.17			●	7,010
3192004	2 × R0.1 × 16	20.1					2.88°	16.75	17.33	17.96	18.63	—			●	7,010
3192013	2 × R0.3 × 8	12.1					4.79°	8.48	8.77	9.09	9.43	10.2			●	7,010
3192015	2 × R0.3 × 12	16.1					3.6°	12.61	13.05	13.52	14.03	15.17			●	7,010
3192019	2 × R0.5 × 6	10.1					5.75°	6.41	6.63	6.87	7.13	7.71			●	6,640
3192020	2 × R0.5 × 8	12.1					4.79°	8.48	8.77	9.09	9.43	10.2			●	7,010
3192021	2 × R0.5 × 10	14.1					4.11°	10.54	10.91	11.31	11.73	12.68			●	7,010
3192022	2 × R0.5 × 12	16.1					3.6°	12.61	13.05	13.52	14.03	15.17			●	7,010
3193008	3 × R0.3 × 12	14.2	50	1.2	4	2.85	2.03°	12.69	13.13	13.6	14.12	—	4	A	●	7,230

・アイコンの説明はp.9をご覧ください。See p.9 for explanation of icons.

●=標準在庫品 ●= Standard stock item

注1：ワーク勾配角αに対する実有効長 (Le)

Effective neck length (Le) based on the inclination angle (α) of workpiece.

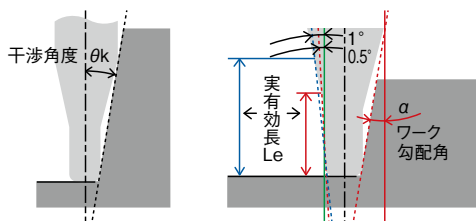

実有効長欄に数値のないものは干渉なしを表します。
No numerical value means no interference with the workpiece.



フェニックス ディープフィーダーボール

Phoenix Deep Feeder Ball Nose End Mill

PAT. in Japan

PHX-DBT

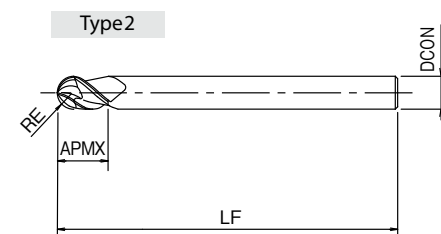
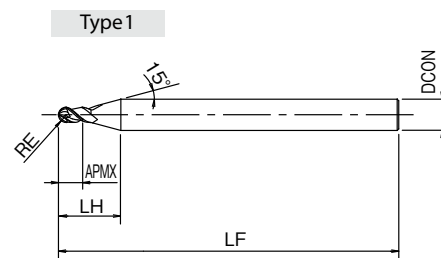

単位:mm Unit:mm

ツールNo. EDP No.	ボール半径×全長 RE × LF	LH	刃長 APMX	シャンク径 DCON	干渉角度 θ_k	ワーク勾配角 α に対する実有効長(Le) ^{注1}					刃数 ZEPF	形状 Type	在庫 Stock	標準価格 (Yen)	
						0.5°	1°	1.5°	2°	3°					
3090202	R 0.5 × 60	12	1.5	6	13.53°	1.53	1.56	1.6	1.65	1.74	3	1	A ●	17,200	
3090204	R 1 × 60	12.3	3	6	11.81°	3.06	3.13	3.21	3.3	3.49	3	1	A ●	17,200	
3090206	R 1.5 × 70	12.6	4.5	6	9.76°	4.6	4.7	4.82	4.95	5.23	3	1	A ●	18,700	
3090208	R 2 × 70	12.2	6	6	7.26°	6.13	6.27	6.43	6.6	6.98	3	1	A ●	18,700	
3090210	R 2.5 × 70	12.1	7.5	6	4.12°	7.66	7.84	8.04	8.25	8.73	3	1	A ●	19,700	
3090212	R 3 × 80	—	9	6	—	—	—	—	—	—	3	2	A	●	20,100
3090312	R 3 × 110													●	21,300
3090216	R 4 × 90	—	12	8	—	—	—	—	—	—	3	2	A	●	26,700
3090316	R 4 × 120													●	27,800
3090220	R 5 × 100	—	15	10	—	—	—	—	—	—	3	2	A	●	36,100
3090320	R 5 × 130													●	38,800
3090222	R 6 × 100	—	18	12	—	—	—	—	—	—	3	2	A	●	47,100
3090322	R 6 × 140													●	51,400
3090226	R 8 × 150	—	24	16	—	—	—	—	—	—	3	2	A	●	80,200
3090230	R 10 × 150													●	126,000
3090330	R 10 × 200	—	30	20	—	—	—	—	—	—	3	2	A	●	137,000

・アイコンの説明はp.9をご覧ください。 See p.9 for explanation of icons.

●=標準在庫品 ●= Standard stock item

注1: ワーク勾配角 α に対する実有効長(Le)

Effective neck length (Le) based on the inclination angle (α) of workpiece.

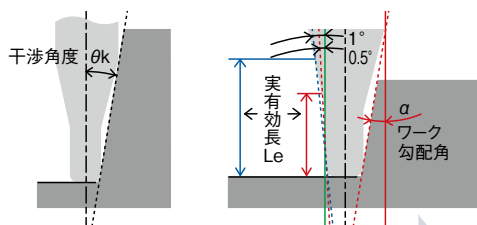

実有効長欄に数値のないものは干渉なしを表します。

No numerical value means no interference with the workpiece.



フェニックス ペンシルネックディープフィーダーボール

Phoenix Pencil Neck Deep Feeder Ball Nose End Mill

PHX-PC-DBT



Type1

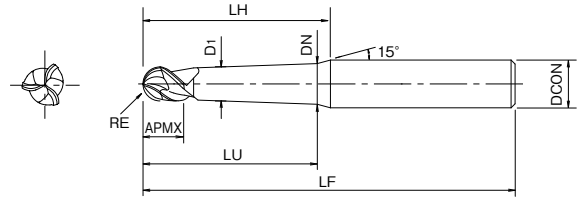

Type2

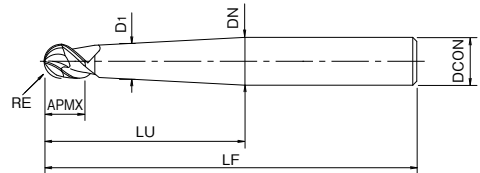

CARBIDE	WXS	R ± 0.01	SHRINK FIT	45°	SPEED FEED P34-38
---------	-----	-------------	---------------	-----	-------------------------

単位:mm Unit:mm

ツールNo. EDP No.	有効勾配角 α	ボール半径×首部テーパ半角×首下長×全長 RE × θn × LU × LF	LH	全長 LF	刃長 APMX	シャンク径 DCON	首径 Di	首元径 DN	干渉角度 θk	ワーク勾配角αに対する実有効長(Le)注1					刃数 ZEFP	形状 Type	在庫 Stock	標準価格 (Yen)	
										0.5°	1°	1.5°	2°	3°					
3094000	0.25°	R0.5 × 0.5° × 8	17.9	60	1.5	6	0.95	1.06	8.49°	8.13	8.4	8.68	8.99	9.68	3	1	A	●	13,000
3094001	0.34°	R0.5 × 0.5° × 12	21.8					1.13	6.92°	12.13	12.54	12.97	13.44	14.49				●	13,100
3095125	0.38°	R0.5 × 0.5° × 16	25.6					1.2	5.84°	16.13	16.68	17.26	17.89	19.3				●	13,200
3094002	0.41°	R0.5 × 0.5° × 20	29.5					1.27	5.04°	20.13	20.82	21.55	22.34	24.11				●	13,300
3095141	0.56°	R0.5 × 1° × 6	15.7					1.1	9.67°	5.75	6.18	6.38	6.61	7.1				●	12,900
3095142	0.68°	R0.5 × 1° × 8	17.6					1.17	8.59°	5.62	6.18	6.38	6.61	7.1				●	13,000
3095143	0.75°	R0.5 × 1° × 10	19.5					1.24	7.74°	5.55	10.18	10.53	10.9	11.75				●	13,000
3095144	0.79°	R0.5 × 1° × 12	21.4					1.31	7.03°	5.51	12.18	12.6	13.05	14.08				●	13,100
3094003	0.83°	R0.5 × 1° × 14	23.3					1.39	6.45°	5.3	14.16	14.65	15.18	16.38				●	13,100
3095145	0.85°	R0.5 × 1° × 16	25.1					1.45	5.95°	5.46	16.18	16.74	17.35	18.72				●	13,200
3094004	0.87°	R0.5 × 1° × 18	27.1					1.53	5.53°	5.31	18.16	18.8	19.48	21.02				●	13,300
3095146	0.88°	R0.5 × 1° × 20	28.8					1.59	5.15°	5.44	20.18	20.89	21.65	23.37				●	13,300
3094005	0.89°	R0.5 × 1° × 22	30.8					1.67	4.83°	5.32	22.16	22.94	23.78	25.67				●	13,400
3094006	0.9°	R0.5 × 1° × 24	32.7					1.74	4.55°	5.32	24.16	25.01	25.93	28				●	13,500
3095147	0.91°	R0.5 × 1° × 25	33.5	1.77	4.42°	5.37	25.17	26.06	27.02	29.17	●	14,100							
3094007	0.91°	R0.5 × 1° × 26	34.5	1.81	4.29°	5.32	26.16	27.08	28.08	30.32	●	14,100							
3094008	0.92°	R0.5 × 1° × 28	36.4	1.88	4.07°	5.32	28.16	29.15	30.23	32.64	●	14,200							
3094009	0.92°	R0.5 × 1° × 30	38.3	1.95	3.86°	5.32	30.15	31.23	32.38	34.97	●	14,200							
3094010	0.93°	R0.5 × 1° × 32	40.1	2.02	3.68°	5.33	32.15	33.3	34.53	37.29	●	14,800							
3094011	0.93°	R0.5 × 1° × 34	42	2.09	3.51°	5.33	34.15	35.37	36.68	39.62	●	14,900							
3094012	0.94°	R0.5 × 1° × 36	43.9	2.16	3.36°	5.33	36.15	37.44	38.83	41.94	●	14,900							
3095155	1.3°	R0.5 × 1.5° × 15	23.7	1.65	6.3°	3.46	6.52	15.22	15.77	17.02	●	13,200							
3094013	1.31°	R0.5 × 1.5° × 16	24.7	1.71	6.07°	3.46	6.36	16.21	16.8	18.12	●	13,200							
3094014	1.35°	R0.5 × 1.5° × 20	28.3	1.92	5.27°	3.43	6.35	20.21	20.94	22.61	●	13,300							
3094015	1.38°	R0.5 × 1.5° × 24	31.9	2.13	4.65°	3.43	6.35	24.2	25.09	27.09	●	13,500							
3095157	1.39°	R0.5 × 1.5° × 25	32.7	2.18	4.52°	3.43	6.38	25.21	26.14	28.22	●	14,100							
3094016	1.4°	R0.5 × 1.5° × 30	37.4	2.44	3.96°	3.44	6.4	30.21	31.33	33.83	●	14,200							
3094017	1.43°	R0.5 × 1.5° × 40	46.4	2.97	3.17°	3.44	6.34	40.2	41.69	45.03	●	14,500							
3094018	1.44°	R0.5 × 1.5° × 50	55.4	3.49	2.65°	3.43	6.37	50.21	52.07	—	●	14,800							
3094019	1.45°	R0.5 × 1.5° × 60	64.4	4.02	2.27°	3.43	6.34	60.19	62.43	—	●	15,000							
3095191	4.3°	R0.5 × 4.5° × 30	31.6	5.43	4.68°	1.98	2.2	2.48	2.88	4.48	●	14,300							

・アイコンの説明はp.9をご覧ください。 See p.9 for explanation of icons.

● = 標準在庫品 ● = Standard stock item



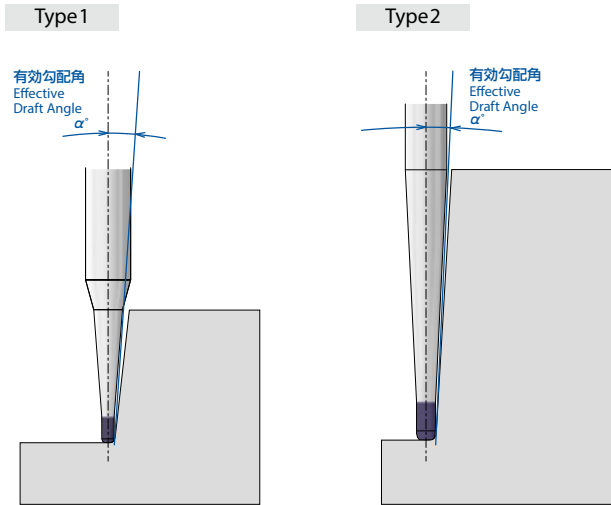

※切削状態によっては、工具がたわみ、勾配部が干渉する場合があります。

The tool may be deflected and may interfere with the draft area depending on milling condition.

※首部テーパ半角 (θn°) は便宜上有効勾配角 (α°) と同表記していますが、実際には異なります。(有効勾配角 (α°)) に干渉しない角度にて設定)

For convenience, the draft angle (θn°) is illustrated the same as the effective draft angle (α°), but they are not identical. The effective draft angle (α°) is configured without interference.

FROM

単位 :mm Unit:mm

ツール No. EDP No.	有効勾配角 α	ボール半径×首部テーパ半角×首下長×全長 $RE \times \theta n \times LU \times LF$	LH	全長 LF	刃長 APMX	シャンク径 DCON	首径 D_1	首元径 DN	干渉角度 θk	ワーク勾配角 α に対する実有効長 (Le) 注1					刃数 Z/EFP	形状 Type	在庫 Stock	標準価格 (Yen)	
										0.5°	1°	1.5°	2°	3°					
3094020	0.45°	R0.75 × 0.7° × 12	20.8	60	2.25	6	1.45	1.67	6.63°	12.05	12.44	12.86	13.32	14.34	3	1	A	●	13,000
3094021	0.52°	R0.75 × 0.7° × 16	24.6					1.77	5.55°	15.35	16.52	17.09	17.7	19.08				●	13,200
3094022	0.56°	R0.75 × 0.7° × 20	28.4					1.87	4.77°	14.53	20.6	21.32	22.09	23.82				●	13,300
3094023	0.61°	R0.75 × 0.7° × 30	38					2.11	3.53°	14.29	30.82	31.9	33.07	35.7				●	14,200
3095211	0.45°	R0.75 × 1° × 6	14.8					1.58	9.43°	6.02	6.2	6.4	6.61	7.09				●	12,900
3094024	0.49°	R0.75 × 1° × 8	16.9					1.63	8.29°	7.75	8.24	8.51	8.8	9.46				●	13,000
3095212	0.65°	R0.75 × 1° × 9	17.6	1.68	7.83°	6.84	9.21	9.52	9.85	10.59	●	13,000							
3094025	0.62°	R0.75 × 1° × 10	18.7	1.7	7.41°	7.4	10.24	10.58	10.95	11.78	●	13,000							
3095213	0.74°	R0.75 × 1° × 12	20.4	1.79	6.71°	6.63	12.2	12.61	13.06	14.06	●	13,100							
3094026	0.74°	R0.75 × 1° × 14	22.5	1.84	6.11°	7.09	14.24	14.73	15.25	16.43	●	13,100							
3095214	0.8°	R0.75 × 1° × 15	23.2	1.89	5.86°	6.72	15.21	15.73	16.3	17.56	●	13,200							
3094027	0.77°	R0.75 × 1° × 16	24.3	1.91	5.61°	7.01	16.24	16.8	17.4	18.76	●	13,200							
3094028	0.8°	R0.75 × 1° × 18	26.2	1.98	5.19°	6.96	18.24	18.87	19.55	21.08	●	13,300							
3094029	0.82°	R0.75 × 1° × 20	28.1	2.05	4.83°	6.91	20.24	20.94	21.7	23.4	●	13,300							
3095215	0.86°	R0.75 × 1° × 21	28.8	2.1	4.67°	6.68	21.21	21.95	22.74	24.53	●	13,400							
3094030	0.86°	R0.75 × 1° × 26	33.7	2.26	4°	6.83	26.24	27.16	28.15	30.38	●	14,100							
3095216	0.9°	R0.75 × 1° × 30	37.3	2.41	3.58°	6.7	30.22	31.28	32.43	35	●	14,300							
3094031	0.92°	R0.75 × 1° × 40	46.8	2.75	2.85°	6.74	40.24	41.66	43.2	—	●	15,100							
3094032	0.93°	R0.75 × 1° × 50	56.1	3.1	2.36°	6.71	50.23	52.02	53.94	—	●	15,800							

注 1: ワーク勾配角 α に対する実有効長 (Le)
Effective neck length (Le) based on the inclination angle (α) of workpiece.

● = 標準在庫品 ● = Standard stock item

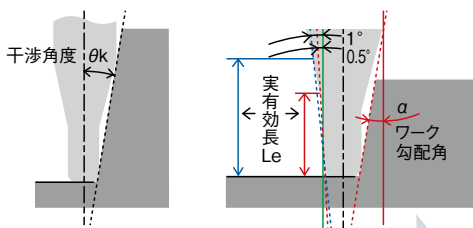

実有効長欄に数値のないものは干渉なしを示します。
No numerical value means no interference with the workpiece.

NEXT



フェニックス ペンシルネックディープフィーダーボール

Phoenix Pencil Neck Deep Feeder Ball Nose End Mill

PHX-PC-DBT



FROM

Type1

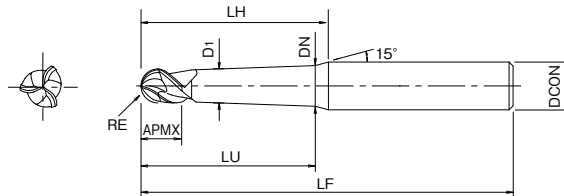

Type2

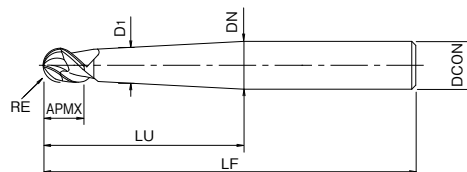

単位:mm Unit:mm

ツールNo. EDP No.	有効勾配角 α	ボール半径×首部テーパ半角×首下長×全長 $RE \times \theta_n \times LU \times LF$	LH	全長 LF	刃長 APMX	シャンク径 DCON	首径 D_i	首元径 DN	干渉角度 θ_k	ワーク勾配角 α に対する実有効長(Le) ^{注1}					刃数 ZEFP	形状 Type	在庫 Stock	標準価格 (Yen)
										0.5°	1°	1.5°	2°	3°				
3094033	0.21°	R1 ×0.5° × 10	18	60	3	6	1.95	2.06	6.95°	10.18	10.5	10.85	11.22	12.05	3	1	A	● 12,800
3095223	0.38°	R1 ×0.5° × 20	27.6					2.24	4.39°	20.17	20.84	21.56	22.33	24.06				● 13,300
3094034	0.41°	R1 ×0.5° × 30	37.4	70	3	6	1.95	2.41	3.21°	30.18	31.2	32.29	33.46	36.1	3	1	A	● 14,000
3095241	0.62°	R1 ×1° × 10	17.7					2.19	7.06°	8.05	10.24	10.58	10.94	11.75				● 13,000
3094035	0.64°	R1 ×1° × 12	19.7	60	3	6	1.95	2.24	6.32°	8.75	12.28	12.69	13.13	14.12	3	1	A	● 13,100
3094036	0.69°	R1 ×1° × 14	21.6					2.31	5.73°	8.56	14.28	14.76	15.28	16.44				● 13,100
3095242	0.76°	R1 ×1° × 15	22.4	60	3	6	1.95	2.36	5.49°	8.08	15.25	15.77	16.32	17.57	3	1	A	● 13,200
3094037	0.74°	R1 ×1° × 16	23.5					2.38	5.25°	8.44	16.28	16.84	17.43	18.77				● 13,200
3094038	0.77°	R1 ×1° × 18	25.3	70	3	6	1.95	2.45	4.84°	8.35	18.28	18.91	19.58	21.09	3	1	A	● 13,300
3095243	0.82°	R1 ×1° × 20	27					2.54	4.49°	7.93	20.24	20.94	21.69	23.37				● 13,300
3094039	0.83°	R1 ×1° × 24	30.9	70	3	6	1.95	2.66	3.91°	8.2	24.28	25.12	26.03	28.06	3	1	A	● 13,400
3095244	0.86°	R1 ×1° × 25	31.7					2.71	3.8°	7.97	25.25	26.13	27.07	29.19				● 14,100
3094040	0.84°	R1 ×1° × 26	32.8	80	3	6	1.95	2.73	3.68°	8.16	26.28	27.19	28.18	30.39	3	1	A	● 14,100
3095245	0.89°	R1 ×1° × 30	36.4					2.89	3.29°	7.9	30.24	31.3	32.43	34.99				● 14,800
3095246	0.92°	R1 ×1° × 40	45.7	100	3	6	1.95	3.24	2.6°	7.88	40.24	41.66	43.18	—	3	1	A	● 15,100
3095247	0.93°	R1 ×1° × 50	55.1					3.59	2.15°	7.87	50.24	52.02	53.93	—				● 16,700
3094041	1.15°	R1 ×1.5° × 16	23.1	60	3	6	1.95	2.6	5.35°	5.61	10.96	16.38	16.96	18.26	3	1	A	● 13,200
3094042	1.22°	R1 ×1.5° × 20	26.7					2.81	4.58°	5.56	10.66	20.38	21.11	22.74				● 13,300
3094043	1.27°	R1 ×1.5° × 24	30.3	80	3	6	1.95	3.02	4.01°	5.54	10.49	24.38	25.26	27.23	3	1	A	● 13,400
3094044	1.32°	R1 ×1.5° × 30	35.7					3.33	3.37°	5.52	10.41	30.39	31.49	33.97				● 14,800
3095251	1.39°	R1 ×1.5° × 40	44.5	100	3	6	1.95	3.88	2.67°	5.45	9.96	40.33	41.81	—	3	1	A	● 16,800
3094045	1.40°	R1 ×1.5° × 50	53.7					4.38	2.21°	5.48	10.15	50.38	52.23	—				● 16,700
3094046	1.41°	R1 ×1.5° × 60	62.8	80	3	6	1.95	—	1.85°	6.38	18.56	61.46	—	—	3	1	A	● 18,700
3095262	1.93°	R1 ×2° × 60.3	—					—	1.94°	4.6	6.36	11.49	—	—				● 18,700
3095273	2.85°	R1 ×3° × 41.2	—	80	3	6	1.95	2.85°	3.96	4.69	5.9	8.28	—	3	1	A	● 16,800	
3095281	3.94°	R1 ×4° × 30	—					3.95°	3.64	4.04	4.59	5.38	8.81				—	● 16,500

・アイコンの説明はp.9をご覧ください。 See p.9 for explanation of icons.

●=標準在庫品 ●= Standard stock item



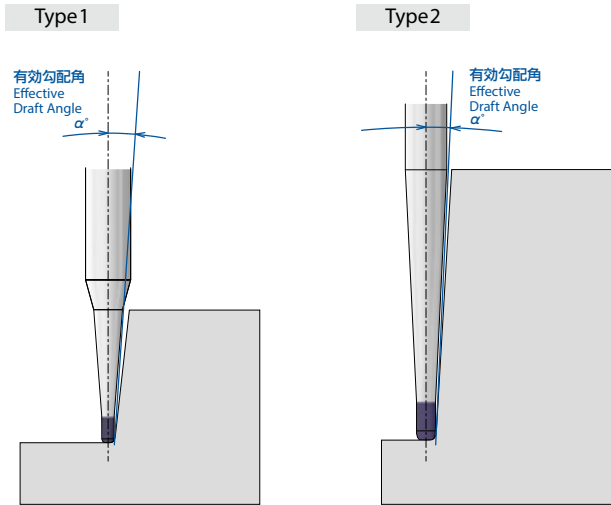

※切削状態によっては、工具がたわみ、勾配部が干渉する場合があります。

The tool may be deflected and may interfere with the draft area depending on milling condition.

※首部テーパ半角 (θn°) は便宜上有効勾配角 (α°) と同表記していますが、実際には異なります。(有効勾配角 (α°) に干渉しない角度にて設定)

For convenience, the draft angle (θn°) is illustrated the same as the effective draft angle (α°), but they are not identical. The effective draft angle (α°) is configured without interference.

FROM

単位 :mm Unit:mm

ツールNo. EDP No.	有効勾配角 α	ボール半径×首部テーパ半角×首下長×全長 $RE \times \theta n \times LU \times LF$	LH	全長 LF	刃長 APMX	シャンク径 DCON	首径 D_1	首元径 DN	干渉角度 θk	ワーク勾配角 α に対する実有効長 (Le) 注1					刃数 Z/EFP	形状 Type	在庫 Stock	標準価格 (Yen)
										0.5°	1°	1.5°	2°	3°				
3094047	0.44°	R1.25 × 0.7° × 16	22.8	60	3.8	6	2.45	2.72	4.79°	16.07	16.58	17.14	17.74	19.08	3	1	A	● 15,900
3094048	0.5°	R1.25 × 0.7° × 20	26.6					2.82	4.05°	20.01	20.66	21.37	22.12	23.82				● 16,200
3094049	0.53°	R1.25 × 0.7° × 24	30.4					2.92	3.51°	20.07	24.74	25.59	26.51	28.56				● 16,500
3094050	0.57°	R1.25 × 0.7° × 30	36.2					3.07	2.93°	19.03	30.86	31.93	33.08	● 16,700				
3094051	0.83°	R1.25 × 1° × 30	35.7					3.33	2.97°	9.66	30.34	31.39	32.53	● 16,700				
3094052	0.88°	R1.25 × 1° × 40	45					3.68	2.33°	9.53	40.34	41.75	43.27	● 17,200				
3094053	0.9°	R1.25 × 1° × 50	54.4					4.03	1.92°	9.45	50.34	52.11	—	—				● 18,200
3094054	1.33°	R1.25 × 1.5° × 40	43.9					4.3	2.39°	6.61	12.41	40.47	41.94	● 17,900				
3094055	1.39°	R1.25 × 1.5° × 60	65.7					5.34	2.48°	6.58	12.24	60.49	62.71	● 20,100				
3094056	1.42°	R1.25 × 1.5° × 80	83.7					6.39	1.93°	6.56	12.1	80.48	—	● 22,000				
3095321	0.27°	R1.5 × 0.5° × 20	26	80	4.5	6	2.9	3.17	3.61°	20.29	20.95	21.65	22.41	24.11	3	A	● 16,200	
3094057	0.51°	R1.5 × 1° × 16	21.8					3.26	4.37°	15.51	16.49	17.03	17.61	18.93			● 15,900	
3095341	0.69°	R1.5 × 1° × 20	25.5					3.44	3.68°	13.27	20.41	21.09	21.83	23.48			● 16,200	
3094058	0.69°	R1.5 × 1° × 24	29.3					3.54	3.17°	14.42	24.49	25.32	26.21	28.22			● 16,500	
3095342	0.76°	R1.5 × 1° × 25	30.1					3.61	3.07°	13.37	25.42	26.28	27.21	29.3			● 16,300	
3094059	0.71°	R1.5 × 1° × 26	31.2					3.79	2.97°	14.29	26.49	27.39	28.36	● 16,300				
3095343	0.8°	R1.5 × 1° × 30	34.8					4.13	2.63°	13.24	30.4	31.45	32.57	● 16,500				
3095344	0.85°	R1.5 × 1° × 40	44.2					4.48	2.05°	13.37	40.42	41.83	43.34	● 16,800				
3095345	0.88°	R1.5 × 1° × 50	53.5					4.83	1.68°	13.33	50.42	52.19	—	—			● 18,200	
3095346	0.9°	R1.5 × 1° × 60	62.9					5.14	1.42°	13.3	60.42	—	—	—			● 18,700	
3094060	0.9°	R1.5 × 1° × 70	72.3	5.14	1.23°	13.61	70.5	—	—	—	● 19,000							
3095356	1.45°	R1.5 × 1.5° × 60.8	—	6	1.45°	8.55	14.68	—	—	—	● 18,700							
3095365	1.91°	R1.5 × 2° × 46.5	—	6	1.91°	7.21	9.77	16.54	—	—	● 18,200							
3095374	2.8°	R1.5 × 3° × 32.1	—	6	2.81°	6.11	7.15	8.81	11.83	—	● 16,600							
3094061	2.6°	R1.5 × 3° × 40	43.6	6.49	3.46°	6.32	7.6	9.79	14.45	41.27	● 17,200							
3094062	2.69°	R1.5 × 3° × 50	55.4	7.54	3.77°	6.3	7.56	9.7	14.19	51.27	● 20,300							
3094063	2.78°	R1.5 × 3° × 70	75.2	9.64	3.53°	6.28	7.52	9.61	13.92	71.26	● 22,200							
3094064	2.83°	R1.5 × 3° × 90	91.3	11.74	2.9°	6.27	7.5	9.56	13.78	—	● 23,300							

注1: ワーク勾配角 α に対する実有効長 (Le)

Effective neck length (Le) based on the inclination angle (α) of workpiece.

● = 標準在庫品 ● = Standard stock item

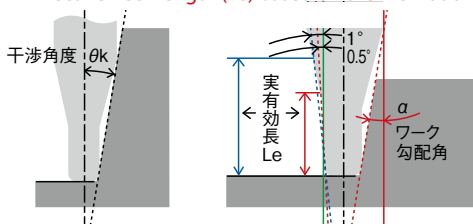

実有効長欄に数値のないものは干渉なしを示します。

No numerical value means no interference with the workpiece.

NEXT

フェニックス ペンシルネックディープフィーダーボール

Phoenix Pencil Neck Deep Feeder Ball Nose End Mill

PHX-PC-DBT



FROM

Type1

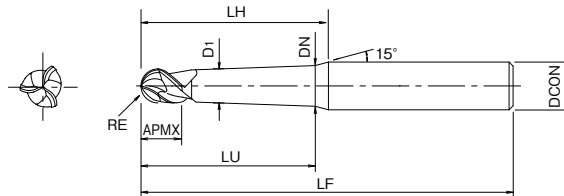

Type2

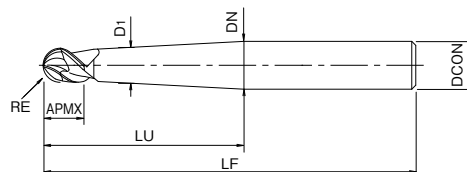

単位:mm Unit:mm

ツールNo. EDP No.	有効勾配角 α	ボール半径×首部テーパ半角×首下長×全長 $RE \times \theta_n \times LU \times LF$	LH	全長 LF	刃長 APMX	シャク径 DCON	首径 D_i	首元径 D_N	干渉角度 θ_k	ワーク勾配角 α に対する実有効長(Le) ^{注1}					刃数 ZEFP	形状 Type	在庫 Stock	標準価格 (Yen)												
										0.5°	1°	1.5°	2°	3°																
3094065	0.58°	R1.75 × 1° × 20	24.7	80	5.3	6	3.4	3.87	3.22°	16.46	20.53	21.21	21.94	23.59	3	1	A	● 16,200												
3094066	0.73°	R1.75 × 1° × 30	34					4.22	2.27°	15.6	30.53	31.57	32.69	—				—	—	—	● 16,500									
3094067	0.8°	R1.75 × 1° × 40	43.4					4.57	1.75°	15.27	40.53	41.93	—	—				—	—	—	● 16,800									
3094068	0.85°	R1.75 × 1° × 50	52.7	100	8	8	3.4	4.92	1.43°	15.09	50.52	—	—	—	3	1	A	● 18,200												
3094069	1.33°	R1.75 × 1.5° × 60	64.1					6.2	2.1°	10.1	19.09	60.72	62.94	—				—	—	—	● 22,000									
3094070	1.38°	R1.75 × 1.5° × 80	82.1					7.25	1.62°	10.06	18.8	80.72	—	—				—	—	—	● 24,100									
3094071	1.4°	R1.75 × 1.5° × 100	103.9	150	10	10	3.4	8.29	1.84°	10.04	18.72	100.73	—	—	3	1	A	● 29,200												
3095421	0.29°	R2 × 0.5° × 25	29	80	6	6	3.9	4.23	2.18°	25.33	26.14	27.01	27.95	3				1	A	● 16,300										
3095441	0.76°	R2 × 1° × 30	33					4.73	1.89°	15.92	30.49	31.52	—							—	—	—	—	● 16,500						
3095442	0.82°	R2 × 1° × 40	42.4					5.08	1.45°	15.85	40.49	—	—		—	—	—			—	● 16,800									
3095443	0.86°	R2 × 1° × 50	51.8	100	8	8	3.9	5.43	1.17°	15.81	50.49	—	—	3	1	A	● 18,200													
3094072	0.86°	R2 × 1° × 60	61.2					5.74	0.98°	16.23	—	—	—				—	—	—	—	● 18,800									
3095444	0.97°	R2 × 1° × 61.3	—					6	0.97°	14.28	—	—	—				—	—	—	—	● 18,800									
3094073	0.89°	R2 × 1° × 70	74.3	120	8	8	3.9	6.09	1.61°	16.14	70.56	73.04	—	—	3	1	A	● 22,700												
3095445	0.92°	R2 × 1° × 80	83.5					6.48	1.42°	15.76	80.48	—	—	—				—	—	—	● 23,100									
3095453	1.42°	R2 × 1.5° × 42.2	—					6	1.43°	10.19	16.4	—	—	—				—	—	—	● 17,000									
3094074	1.32°	R2 × 1.5° × 60	63.2	120	8	8	3.9	6.66	1.9°	11.05	20.83	60.78	—	—	3	1	A	● 22,400												
3095454	1.46°	R2 × 1.5° × 80.4	—					8	1.47°	10.51	17.9	—	—	—				—	—	—	● 23,100									
3094075	1.4°	R2 × 1.5° × 100	103					150	10	10	3.9	8.76	1.72°	10.96				20.31	100.77	—	—	● 27,800								
3094076	1.53°	R2 × 2° × 30	35.4	80	8	8	3.9	5.49	3.5°	9.48	13.67	28.4	31	33.36	3	1	A	● 16,500												
3095462	1.93°	R2 × 2° × 61.3	—	120				1.94°	9	12.12	20.28	—	—	—				—	—	● 22,400										
3094077	1.78°	R2 × 2° × 66.7 × 140	—	140				1.77°	9.39	13.36	26.49	—	—	—				—	—	● 24,900										
3094078	1.78°	R2 × 2° × 66.7 × 160	—	160	8	8	3.9	6.29	3.67°	8.07	9.71	12.58	18.84	31.5	3	1	A	● 27,200												
3094079	2.35°	R2 × 3° × 30	34	80				2.85°	7.77	9.07	11.11	14.79	—	—				—	—	● 16,500										
3095472	2.84°	R2 × 3° × 42.2	—	100				2.54°	8.07	9.7	12.56	18.76	—	—				—	—	● 20,100										
3094080	2.54°	R2 × 3° × 47.1 × 120	—	120	8	8	3.9	8	2.54°	8.07	9.7	12.56	18.76	—	3	2	A	● 22,400												
3094081	2.54°	R2 × 3° × 47.1 × 140	—	140														2	2	2	2	2	2	2	2	2	2	2	A	● 24,900
3094082	2.54°	R2 × 3° × 47.1 × 160	—	160																										2
3094083	2.54°	R2 × 3° × 47.1 × 200	—	200	2	2	2	2	2	2	2	2	2	2	2	A	● 29,900													

・アイコンの説明はp.9をご覧ください。 See p.9 for explanation of icons.

●=標準在庫品 ●= Standard stock item



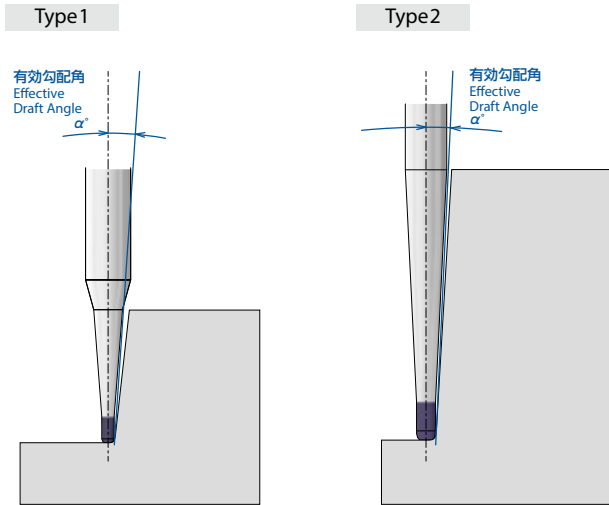

※切削状態によっては、工具がたわみ、勾配部が干渉する場合があります。

The tool may be deflected and may interfere with the draft area depending on milling condition.

※首部テーパ半角 (θn°) は便宜上有効勾配角 (α°) と同表記していますが、実際には異なります。(有効勾配角 (α°)) に干渉しない角度にて設定)

For convenience, the draft angle (θn°) is illustrated the same as the effective draft angle (α°), but they are not identical. The effective draft angle (α°) is configured without interference.

FROM

単位 :mm Unit:mm

ツール No. EDP No.	有効勾配角 α	ボール半径×首部テーパ半角×首下長×全長 RE × θn × LU × LF	LH	全長 LF	刃長 APMX	シャンク径 DCON	首径 D _i	首元径 DN	干渉角度 θk	ワーク勾配角 α に対する実有効長 (Le) 注1					刃数 Z/EFP	形状 Type	在庫 Stock	標準価格 (Yen)				
										0.5°	1°	1.5°	2°	3°								
3094084	0.67°	R2.5 × 1° × 30	35.1	80	7.5	8	4.9	5.64	2.69°	19.64	30.64	31.65	32.75	3	A	●	16,500					
3095541	0.76°	R2.5 × 1° × 35	39.7	100				5.86	2.36°	18.24	35.54	36.74	38.03				●	20,400				
3094085	0.76°	R2.5 × 1° × 40	44.5	80				5.99	2.09°	19.15	40.63	42.01	43.5					●	20,100			
3095542	0.84°	R2.5 × 1° × 50	53.7	100				6.38	1.7°	18.29	50.55	52.29	●						21,100			
3094086	0.85°	R2.5 × 1° × 60	63.2					6.69	1.44°	18.76	60.63	●							21,400			
3095543	0.89°	R2.5 × 1° × 70	72.4	130				7.08	1.25°	18.26	70.55								●	24,000		
3094087	0.89°	R2.5 × 1° × 80	81.9					7.39	1.1°	18.6	80.63									●	24,300	
3095544	0.98°	R2.5 × 1° × 90.4	—	10				8	0.98°	16.9	—										●	24,900
3095553	1.45°	R2.5 × 1.5° × 61.8	—						1.45°	12.23	19.91											●
3094088	1.36°	R2.5 × 1.5° × 90	92.3	8				9.15	1.61°	13	24.08											
3095562	1.91°	R2.5 × 2° × 47.5	—		8	8	1.91°	10.62	13.96	21.97	●			23,500								
3095641	0.77°	R3 × 1° × 40	42.6	100	8	5.9	6.98	1.48°	20.79	40.62				●	22,200							
3095642	0.82°	R3 × 1° × 50	51.9				7.33	1.19°	20.76	50.62					●	22,700						
3094089	0.83°	R3 × 1° × 60	65.1				10	7.64	1.87°	21.3			60.7			62.78	●	27,200				
3095643	0.97°	R3 × 1° × 62.3	—	8	8	0.97°	18.34	—	●	25,200												
3095644	0.9°	R3 × 1° × 90	93.1		10	8.72	1.29°	20.81		90.63		●	29,700									
3095651	1.42°	R3 × 1.5° × 43.2	—	100	8	1.43°	13.66	20.72		●			22,400									
3095653	1.46°	R3 × 1.5° × 81.4	—	130	10	1.47°	14.23	23.29					●			29,200						
3095661	1.87°	R3 × 2° × 33.6	—	100	8	1.87°	12.02	15.15								21.62		●	22,000			
3095662	1.93°	R3 × 2° × 62.3	—	130	10	1.94°	12.45	16.39								25.96			●	28,600		
3094090	1.72°	R3 × 2° × 69.7 × 130	—			1.72°	13.09	18.51			36.44					●				29,700		
3094091	1.72°	R3 × 2° × 69.7 × 160	—	160	10	10	2.43°	11.49			13.79			17.79						26.47	●	32,700
3094092	2.44°	R3 × 3° × 50.1 × 130	—	130											●							29,700
3094093	2.44°	R3 × 3° × 50.1 × 160	—	160													●					32,700
3094094	2.44°	R3 × 3° × 50.1 × 200	—	200	●	35,900																

注 1: ワーク勾配角 α に対する実有効長 (Le)
Effective neck length (Le) based on the inclination angle (α) of workpiece.

● = 標準在庫品 ● = Standard stock item

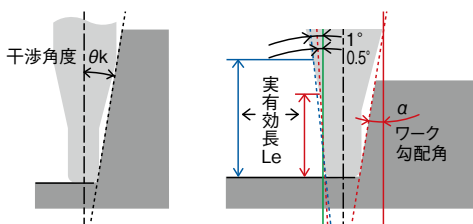

実有効長欄に数値のないものは干渉なしを表します。
No numerical value means no interference with the workpiece.

NEXT



フェニックス ペンシルネックディープフィーダーボール

Phoenix Pencil Neck Deep Feeder Ball Nose End Mill

PHX-PC-DBT



CARBIDE
WXS
R ±0.01
SHRINK FIT
45°
SPEED FEED P34-38

FROM

Type1

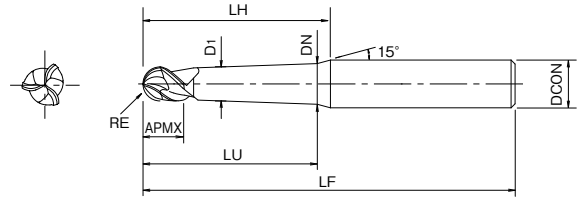

Type2

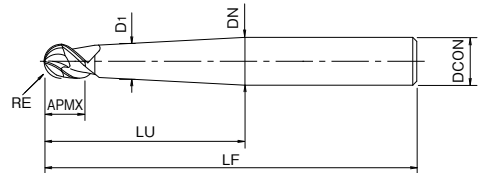

単位:mm Unit:mm

ツールNo. EDP No.	有効勾配角 α	ボール半径×首部テーパ半角×首下長×全長 RE × θn × LU × LF	LH	全長 LF	刃長 APMX	シャク径 DCON	首径 Di	首元径 DN	干渉角度 θk	ワーク勾配角αに対する実有効長(Le)注1					刃数 ZEFP	形状 Type	在庫 Stock	標準価格 (Yen)	
										0.5°	1°	1.5°	2°	3°					
3094095	0.67°	R4 × 1° × 40	42.9	100	12	10	7.9	8.83	1.5°	27.22	40.85	3	A	1	●	26,200			
3095841	0.77°	R4 × 1° × 50	52.3	9.22				1.21°	25.88	50.77	2				●	29,200			
3095842	0.97°	R4 × 1° × 63.3	—	10				0.97°	22.22	—					1	●	29,700		
3094096	0.82°	R4 × 1° × 70	70.9	9.88				0.87°	26.38	1	●					30,200			
3094097	0.85°	R4 × 1° × 80	84	10.23				1.45°	26.27		80.84				1	●	36,400		
3095843	0.88°	R4 × 1° × 90	93.4	10.62				1.3°	25.78	90.76	1					●	38,500		
3094098	0.88°	R4 × 1° × 100	102.7	10.93		1.17°	26.13	100.84	3	A		●	39,900						
3095844	0.98°	R4 × 1° × 120.6	—	12		0.99°	23.82	—			2	●	43,400						
3095851	1.42°	R4 × 1.5° × 44.2	—	10		1.43°	17.02	24.55	1	●		28,900							
3094099	1.21°	R4 × 1.5° × 60	63.8	10.35		1.94°	19.14	35.59		61.21	2	●	35,000						
3095853	1.46°	R4 × 1.5° × 82.4	—	12		1.47°	17.88	28.31	—	2		●	38,000						
3094100	1.3°	R4 × 1.5° × 92.3	—	12		1.3°	19.14	35.56	—		2	●	38,000						
3095862	1.93°	R4 × 2° × 63.3	—	12	1.93°	15.84	20.45	30.94	2	●		35,000							
3094101	1.67°	R4 × 2° × 72.7 × 150	—	150	1.67°	16.79	23.66	46.38		2	●	38,000							
3094102	1.67°	R4 × 2° × 72.7 × 160	—	160	1.67°	16.79	23.66	46.38	2		●	42,000							
3094103	0.69°	R5 × 1° × 50	52.4	120	15	12	9.9	11.08		1.23°	31.91	50.98	3	A	1	●	39,100		
3096041	0.97°	R5 × 1° × 64.3	—	12				0.97°	25.93	—	2	●				40,100			
3096042	0.83°	R5 × 1° × 80	88	12.16				2.09°	30.88	80.91		83.66				86.61	1	●	58,800
3096043	0.87°	R5 × 1° × 100	106.7	12.86				1.71°	30.83	100.91	104.38	1				●		59,300	
3096044	0.89°	R5 × 1° × 120	125.4	13.56				1.44°	30.8	120.91	—					—	3	A	●
3096045	0.91°	R5 × 1° × 140	144.1	14.26				1.25°	30.78	140.9	—	—				3			A
3096046	0.92°	R5 × 1° × 160	162.8	14.96		1.1°	30.76	160.9	—	—	2	A	●	74,300					
3096051	1.42°	R5 × 1.5° × 45.2	—	12		1.43°	20.28	28.01	—	—			1	A	●	39,500			
3094104	1.24°	R5 × 1.5° × 80	85.9	13.24		2.15°	23.1	42.35	81.42	84.3	2	A			●	58,800			
3096053	1.47°	R5 × 1.5° × 121.6	—	16		1.48°	21.91	35.2	—	—			2	A	●	64,200			
3096061	1.87°	R5 × 2° × 35.6	—	12		1.87°	18.25	21.72	27.65	—	2	A			●	39,100			
3096064	1.95°	R5 × 2° × 92.9	—	160		1.96°	19.52	25.38	39.18	—			2	A	●	59,100			

・アイコンの説明はp.9をご覧ください。See p.9 for explanation of icons.

●=標準在庫品 ●= Standard stock item



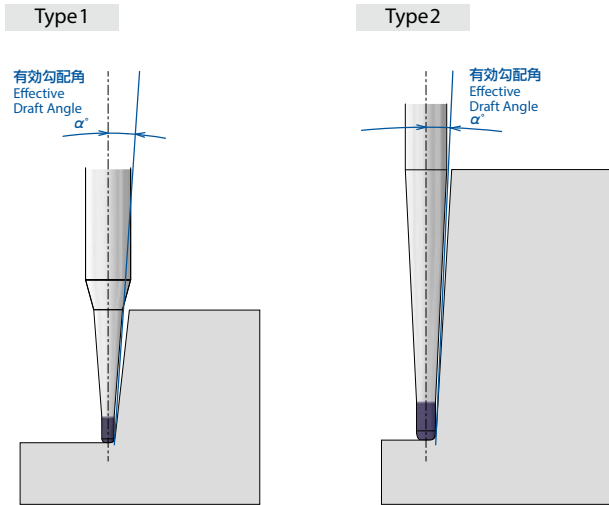

※切削状態によっては、工具がたわみ、勾配部が干渉する場合があります。

The tool may be deflected and may interfere with the draft area depending on milling condition.

※首部テーパ半角 (θn°) は便宜上有効勾配角 (α°) と同表記していますが、実際には異なります。(有効勾配角 (α°)) に干渉しない角度にて設定)

For convenience, the draft angle (θn°) is illustrated the same as the effective draft angle (α°), but they are not identical. The effective draft angle (α°) is configured without interference.

FROM

単位 :mm Unit:mm

ツールNo. EDP No.	有効勾配角 α	ボール半径×首部テーパ半角×首下長×全長 $RE \times \theta n \times LU \times LF$	LH	全長 LF	刃長 APMX	シャンク径 DCON	首径 D1	首元径 DN	干渉角度 θk	ワーク勾配角 α に対する実有効長 (Le) 注1					刃数 ZEF	形状 Type	在庫 Stock	標準価格 (Yen)				
										0.5°	1°	1.5°	2°	3°								
3096241	0.73°	R6 × 1° × 60	65.8	120	18	16	11.9	13.36	1.95°	35.9	61.05	63.04	3	1	A	●	56,400					
3094105	0.77°	R6 × 1° × 80	84.5	160				13.98	1.48°	37.25	81.2	—				—	—	—	—	—	●	58,800
3096242	0.85°	R6 × 1° × 100	103.2	180				14.76	1.19°	35.79	101.04										—	—
3096243	0.98°	R6 × 1° × 122.6	—	—				16	0.99°	32.25	—	—				—	—	—	—	—		
3096244	0.91°	R6 × 1° × 160	166.7	220				16.85	1.44°	35.8	161.05										—	—
3094106	1.18°	R6 × 1.5° × 80	90	130				15.03	2.75°	27.38	51.44	81.75				84.6	—	—	—	—		
3096254	1.48°	R6 × 1.5° × 160.8	—	220	20	1.48°	25.89	41.87	—	—	—	—	—	—	●	104,000						

注1: ワーク勾配角 α に対する実有効長 (Le)
Effective neck length (Le) based on the inclination angle (α) of workpiece.

● = 標準在庫品 ● = Standard stock item

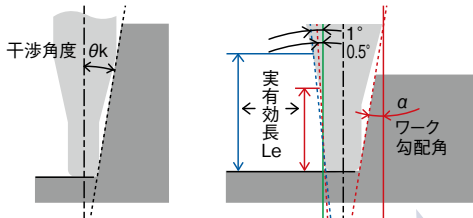

実有効長欄に数値のないものは干渉なしを表します。
No numerical value means no interference with the workpiece.

フェニックス ロングネックボール

Phoenix Long Neck Ball Nose End Mill

PHX-LN-DBT



Type1

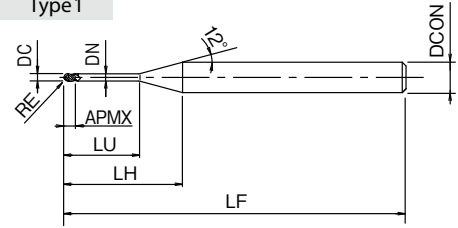

Type2

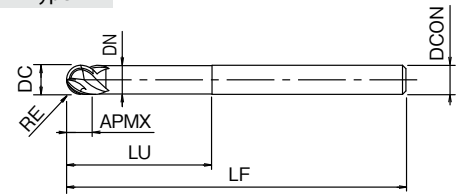

CARBIDE

WXS

R
± 0.007

SHRINK
FIT

45°

SPEED
FEED
P39

単位:mm Unit:mm

ツールNo. EDP No.	ボール半径×首下長 RE × LU	LH	全長 LF	刃長 APMX	シャンク径 DCON	首径 DN	干渉角度 θ _k	ワーク勾配角αに対する実有効長 (Le) ^{注1}					刃数 ZEPF	形状 Type	在庫 Stock	標準価格 (Yen)	
								0.5°	1°	1.5°	2°	3°					
3194901	R 0.3 × 1	9.1	50	0.45	4	0.55	10.89°	1.15	1.19	1.23	1.27	1.38	3	1	B	●	4,040
3194902	R 0.3 × 2	10.1					9.81°	2.19	2.28	2.37	2.47	2.71				●	4,040
3194903	R 0.3 × 3	11.1					8.92°	3.23	3.36	3.51	3.67	4.04				●	4,040
3194904	R 0.3 × 4	12.1					8.18°	4.28	4.45	4.65	4.86	5.36				●	4,230
3194906	R 0.3 × 6	14.1					7.01°	6.36	6.63	6.93	7.26	8.02				●	4,230
3195004	R 0.5 × 4	11.2					7.98°	4.27	4.44	4.62	4.83	5.3				●	3,850
3195006	R 0.5 × 6	13.2	50	0.75	4	0.95	6.74°	6.35	6.62	6.9	7.22	7.96	3	1	B	●	4,110
3195008	R 0.5 × 8	15.2					5.83°	8.44	8.79	9.18	9.61	10.61				●	4,110
3195010	R 0.5 × 10	17.2					5.14°	10.52	10.97	11.46	12.01	13.26				●	4,110
3195012	R 0.5 × 12	19.2					4.59°	12.61	13.15	13.75	14.4	15.92				●	4,110
3195014	R 0.5 × 14	21.2					4.15°	14.7	15.33	16.03	16.79	18.57				●	4,860
3195016	R 0.5 × 16	23.2					3.79°	16.78	17.51	18.31	19.18	21.23				●	5,680
3195106	R 0.75 × 6	12	50	1.13	4	1.45	6.32°	6.34	6.59	6.87	7.17	7.88	3	1	B	●	3,910
3195108	R 0.75 × 8	14					5.38°	8.43	8.77	9.15	9.56	10.53				●	4,110
3195110	R 0.75 × 10	16					4.68°	10.51	10.95	11.43	11.96	13.18				●	4,490
3195112	R 0.75 × 12	18					4.14°	12.6	13.13	13.71	14.35	15.84				●	4,860
3195116	R 0.75 × 16	22					3.37°	16.77	17.49	18.27	19.14	21.15				●	4,860
3195206	R 1 × 6	11					50	1.5	4	1.95	5.79°	6.33				6.57	6.83
3195208	R 1 × 8	13	4.82°	8.42	8.75	9.11					9.52	10.45	●	4,110			
3195210	R 1 × 10	15	4.13°	10.5	10.93	11.4					11.91	13.1	●	4,110			
3195212	R 1 × 12	17	3.61°	12.59	13.11	13.68					14.3	15.76	●	4,110			
3195214	R 1 × 14	19	3.21°	14.67	15.29	15.96					16.69	18.41	●	4,110			
3195216	R 1 × 16	21	2.89°	16.76	17.47	18.24					19.09	—	●	4,110			
3195218	R 1 × 18	23	60	2.25	4	2.85	2.63°	18.85	19.64	20.52	21.48	3	1	B	●	4,110	
3195220	R 1 × 20	25					2.41°	20.93	21.82	22.8	23.87				—	●	4,110
3195222	R 1 × 22	27					2.22°	23.02	24	25.08	26.27				—	●	5,680
3195312	R 1.5 × 12	14.5					2.17°	12.81	13.32	13.88	14.49				—	●	4,760
3195316	R 1.5 × 16	18.5	60	2.25	4	2.85	1.67°	16.98	17.68	18.44	3	1	B	●	5,610		
3195320	R 1.5 × 20	22.5					1.35°	21.16	22.04	—				—	—	●	5,410
3195325	R 1.5 × 25	27.5					1.1°	26.37	27.48	—				—	—	●	5,410
3195416	R 2 × 16	—					60	3	4	3.85				—	—	—	—
3195420	R 2 × 20	—	—	—	—	—					—	—	●	5,610			
3195425	R 2 × 25	—	—	—	—	—					—	—	●	5,610			
3195520	R 3 × 20	—	70	4.5	6	5.85	—	—	—	—	3	2	B	●	7,000		
3195530	R 3 × 30	—					—	—	—	—				—	—	●	7,170

・アイコンの説明はp.9をご覧ください。See p.9 for explanation of icons.

●=標準在庫品 ●= Standard stock item

注1: ワーク勾配角αに対する実有効長 (Le) : P.28を参照下さい。

Please see p.28 for effective neck length (Le) based on the inclination angle (α) of workpiece.



フェニックス ハイフィーダーブルノーズ

Phoenix High Feeder Bull Nose End Mill

PHX-CRT

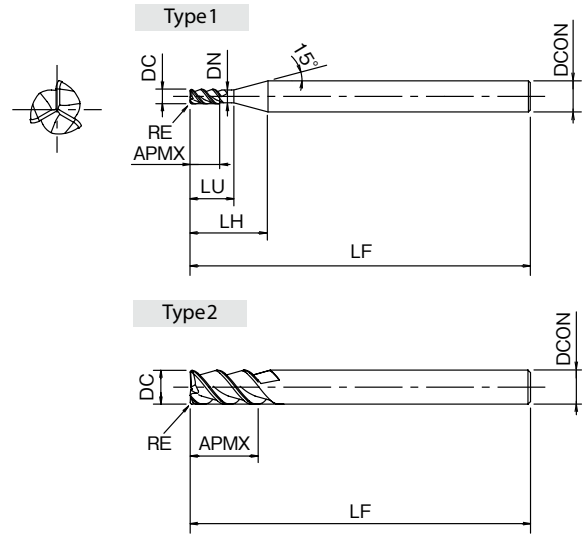

CARBIDE **FX** ± 0.01 **SHRINK** **FIT** **55°** **SPEED FEED P29-32**

DC ≤ 5 0~0.015
6 ≤ DC 0.01~0.005

単位:mm Unit:mm

ツールNo. EDP No.	外径×コーナ半径 DC × RE	首下長 LU	LH	全長 LF	刃長 APMX	シャンク径 DCON	首径 DN	干渉角度 θ_k	ワーク勾配角 α に対する実有効長 (Le) 注1					刃数 ZFP	形状 Type	在庫 Stock	標準価格 (Yen)
									0.5°	1°	1.5°	2°	3°				
3090002	1 × R 0.3	4	13.9	60	2	6	0.95	10.55°	4.23	4.37	4.53	4.7	5.08	3	1	A ●	21,300
3090003	1.5 × R 0.3	4.5	12.9	60	3	6	1.45	9.83°	4.74	4.91	5.09	5.28	5.71	3	1	A ●	21,300
3090004	2 × R 0.5	6	14.0	60	4	6	1.95	8.4°	6.29	6.51	6.75	7	7.57	3	1	A ●	20,300
3090006	3 × R 0.8	9	14.9	70	6	6	2.85	5.76°	9.59	9.92	10.28	10.67	11.53	3	1	A ●	20,100
3090008	4 × R 1	12	16.1	70	8	6	3.85	3.58°	12.69	13.13	13.6	14.12	15.26	3	1	A ●	20,100
3090010	5 × R 1	15	17.2	70	10	6	4.85	1.68°	15.79	16.34	16.93	—	—	3	1	A ●	20,300
3090012	6 × R 1.5	—	—	80	12	6	—	—	—	—	—	—	—	3	2	A ▲	21,700
3090016	8 × R 2	—	—	90	16	8	—	—	—	—	—	—	—	3	2	A ▲	27,900
3090020	10 × R 2	—	—	100	20	10	—	—	—	—	—	—	—	3	2	A ▲	34,700
3090022	12 × R 2	—	—	120	24	12	—	—	—	—	—	—	—	3	2	A ▲	46,300
3090026	16 × R 3	—	—	130	32	16	—	—	—	—	—	—	—	3	2	A ▲	94,200
3090030	20 × R 3	—	—	150	40	20	—	—	—	—	—	—	—	3	2	A ▲	132,000

▲ = この製品は、PHX-DFR(P.9)へ切り替え生産させていただいております。(在庫をご確認下さい。)

▲ = These products have been stopped producing and replaced by PHX-DFR (p.9)

・アイコンの説明はp.9をご覧ください。 See p.9 for explanation of icons.

● = 標準在庫品 ● = Standard stock item

▲ = 新製品及び後継品へ切り替え生産(在庫をご確認下さい。)

▲ = Scheduled to be replaced by new product or successor item

注1: ワーク勾配角 α に対する実有効長 (Le)

Effective neck length (Le) based on the inclination angle (α) of workpiece.

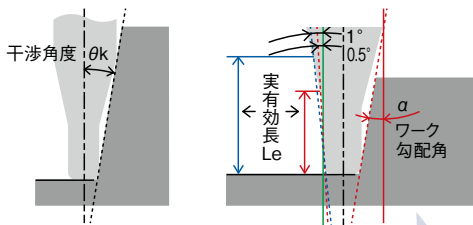

実有効長欄に数値のないものは干渉なしを示します。

No numerical value means no interference with the workpiece.



特長
Features

ブルノーズ
Bull Nose
PHX-CRT

ブルノーズ
Bull Nose
PHX-PC-DFR

ブルノーズ
Bull Nose
PHX-LN-DFR

ブルノーズ
Bull Nose
PHX-LN-CRE

ボール
Ball Nose
PHX-DBT

ボール
Ball Nose
PHX-PC-DBT

ボール
Ball Nose
PHX-LN-DBT

ブルノーズ
Bull Nose
PHX-CRT

切削条件
Cutting Conditions

被削材 Work Material				快削材 高能率荒取り条件 ~40HRC High feed roughing of free-cutting materials		びびり抑制条件 Vibration control conditions										
						高じん性金型材 中荒取り条件 38~53HRC Semi-roughing in high toughness mold materials				仕上げ加工条件 ~55HRC Machining Conditions For Finishing						
				調質鋼・プリハードン鋼 Hardened Steel・Prehardened Steel												
外径 DC	RE	首下長 LU	推奨傾斜 切込角度 Recommended Cutting Angle	回転速度 Speed (min ⁻¹)	送り速度 Feed (mm/min)	切込深さ(mm) Depth of Cut		回転速度 Speed (min ⁻¹)	送り速度 Feed (mm/min)	切込深さ(mm) Depth of Cut		回転速度 Speed (min ⁻¹)	送り速度 Feed (mm/min)	切込深さ(mm) Depth of Cut		仕上げ代 (mm) Clearance
						ap	ae			ap	ae			ap	ae	
1	R0.3	10	0.3°	16,000	900	0.03	0.14	16,000	900	0.03	0.14	16,000	900	0.04	0.14	0.05
		15		8,000	450	0.03	0.14	8,000	450	0.02	0.14	8,000	450	0.04	0.14	0.05
		20		6,000	350	0.02	0.14	6,000	350	0.02	0.14	6,000	350	0.04	0.14	0.03
		25		6,000	300	0.01	0.13	6,000	300	0.01	0.13	6,000	300	0.04	0.14	0.03
		30		6,000	250	0.01	0.12	6,000	250	0.01	0.12	6,000	250	0.04	0.14	0.03
1.5	R0.3	10	0.3°	16,000	1,400	0.05	0.3	16,000	1,200	0.05	0.3	16,000	1,400	0.04	0.35	0.07
		15		8,000	800	0.05	0.3	8,000	600	0.05	0.3	8,000	800	0.04	0.35	0.05
		20		5,500	550	0.04	0.3	5,500	500	0.04	0.3	5,500	550	0.04	0.35	0.05
		25		5,000	500	0.04	0.3	5,000	450	0.04	0.3	5,000	500	0.04	0.35	0.03
		30		4,500	450	0.04	0.3	4,500	400	0.04	0.3	4,500	450	0.04	0.35	0.03
2	R0.5	10	0.3°	12,000	1,450	0.15	0.4	12,000	1,100	0.15	0.4	12,000	1,100	0.06	0.4	0.07
		15		7,800	900	0.12	0.4	7,800	700	0.1	0.4	7,800	700	0.06	0.4	0.07
		20		6,200	750	0.1	0.3	6,200	600	0.07	0.3	6,200	600	0.06	0.4	0.05
		25		4,700	550	0.07	0.3	4,700	500	0.06	0.3	4,700	500	0.06	0.4	0.05
		30		3,500	400	0.07	0.3	3,500	400	0.05	0.3	3,500	400	0.06	0.4	0.05
		35		3,500	400	0.07	0.2	3,500	400	0.04	0.2	3,500	400	0.06	0.4	0.03
		40		3,500	300	0.07	0.2	3,500	300	0.04	0.2	3,500	300	0.06	0.4	0.03
		45		3,500	200	0.07	0.2	3,500	200	0.03	0.2	3,500	200	0.06	0.4	0.03
		50		3,500	150	0.06	0.1	3,500	150	0.03	0.1	3,500	200	0.06	0.4	0.03
		60		3,500	150	0.05	0.1	3,500	150	0.03	0.1	3,500	200	0.06	0.4	0.03
2.5	R0.8	15	0.3°	8,900	800	0.15	0.4	8,900	800	0.15	0.4	8,900	800	0.08	0.4	0.07
		20		6,300	570	0.15	0.4	6,300	570	0.15	0.4	6,300	570	0.08	0.4	0.07
		25		5,100	460	0.12	0.3	5,100	460	0.12	0.3	5,100	460	0.08	0.4	0.05
		30		3,800	340	0.12	0.3	3,800	340	0.12	0.3	3,800	340	0.08	0.4	0.03
		40		2,800	250	0.1	0.3	2,800	250	0.1	0.3	2,800	250	0.08	0.4	0.03
		50		2,800	250	0.08	0.2	2,800	250	0.08	0.2	2,800	250	0.08	0.4	0.03
		60		2,800	250	0.08	0.2	2,800	250	0.08	0.2	2,800	250	0.08	0.4	0.03

- 上記の突出し長別条件は目安です。実際の加工条件に合わせて調節下さい。
- 機械、ホルダは剛性の高いものをご使用下さい。
- 工具の振れ精度を最小限に抑えてご使用下さい。
- 切削油剤は被削材に適したもので、発煙性の少ないものを選定して下さい。通常エアブローを推奨致します。
- 走査線加工を行う場合は、aeの数値を使用せずに、apの数値を参考に使用下さい。
- CAMや機械側でコーナ部のR挿入もしくは減速を設定することで、より安定した高送り加工が可能となります。
- コーナ部等切削負荷が変動する場合や加工精度を要求される場合には、回転速度を抑えてご使用下さい。
- 推奨傾斜切込み角度以上で加工される場合には、送り速度を下げてください。
- 切込深さが切削条件表より小さい場合、送り速度を最大150%を目安に調整して加工も可能です。
- 切込深さが切削条件表より大きくなる場合は、最大60%に減速する事で安定した加工が可能です。

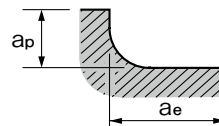

FROM

被削材 Work Material				快削材 高効率荒取り条件 ~40HRC High feed roughing of free-cutting materials		びびり抑制条件 Vibration control conditions										
				高じん性金型材 中荒取り条件 38 ~ 53HRC Semi-roughing in high toughness mold materials				仕上げ加工条件 ~55HRC Machining Conditions For Finishing								
				調質鋼・プリハードン鋼 Hardened Steel · Prehardened Steel												
				SKT4 · SKD61 · NAK80 · HPM1 · DH**				DH** · DAC**				SKT4 · SKD61 · NAK80 · HPM1 · DH**				
外径 DC	RE	首下長 LU	推奨傾斜 切込角度 Recommended Cutting Angle	回転速度 Speed (min ⁻¹)	送り速度 Feed (mm/min)	切込深さ(mm) Depth of Cut		回転速度 Speed (min ⁻¹)	送り速度 Feed (mm/min)	切込深さ(mm) Depth of Cut		回転速度 Speed (min ⁻¹)	送り速度 Feed (mm/min)	切込深さ(mm) Depth of Cut		仕上げ代 (mm) Clearance
						ap	ae			ap	ae			ap	ae	
3	R0.5	40	0.3°	2,600	450	0.08	0.3	2,600	400	0.08	0.3	2,600	550	0.1	0.5	0.03
		60		2,200	350	0.04	0.3	2,200	300	0.04	0.3	2,200	450	0.1	0.5	0.03
	R0.8	10		11,000	1,650	0.13	0.6	8,000	1,200	0.13	0.6	11,000	2,100	0.1	0.5	0.1
		15		10,000	1,500	0.13	0.6	8,000	1,200	0.13	0.6	10,000	1,900	0.1	0.5	0.07
		20		7,500	1,100	0.12	0.5	7,200	1,000	0.12	0.5	7,500	1,400	0.1	0.5	0.07
		25		4,800	700	0.12	0.4	4,600	650	0.12	0.4	4,800	900	0.1	0.5	0.05
		30		3,800	550	0.1	0.4	3,400	500	0.1	0.4	3,800	750	0.1	0.5	0.03
		40		2,600	450	0.08	0.3	2,600	400	0.08	0.3	2,600	550	0.1	0.5	0.03
		50		2,200	350	0.06	0.3	2,200	300	0.06	0.3	2,200	450	0.1	0.5	0.03
		60		2,200	350	0.04	0.3	2,200	300	0.04	0.3	2,200	450	0.1	0.5	0.03
	80	1,060		100	0.03	0.2	1,060	100	0.03	0.2	1,060	160	0.07	0.35	0.03	
	100	1,060		100	0.03	0.2	1,060	100	0.03	0.2	1,060	160	0.07	0.35	0.03	
4	R0.5	30	0.5°	4,500	1,150	0.15	0.7	4,500	900	0.09	0.7	4,500	1,100	0.12	0.7	0.07
		60		2,100	700	0.08	0.5	2,100	450	0.06	0.5	2,100	500	0.12	0.7	0.03
	R1	10		9,500	2,100	0.2	0.9	6,000	1,250	0.2	0.9	9,500	2,250	0.12	0.8	0.1
		15		9,000	2,000	0.2	0.8	6,000	1,250	0.2	0.8	9,000	2,150	0.12	0.8	0.1
		20		8,200	1,700	0.2	0.7	6,000	1,250	0.14	0.7	8,200	2,000	0.12	0.7	0.1
		25		5,500	1,400	0.15	0.7	5,500	1,150	0.11	0.7	5,500	1,350	0.12	0.7	0.07
		30		4,500	1,150	0.15	0.7	4,500	900	0.09	0.7	4,500	1,100	0.12	0.7	0.07
		35		3,600	1,100	0.12	0.6	3,600	750	0.09	0.6	3,600	900	0.12	0.7	0.05
		40		3,000	900	0.12	0.6	3,000	650	0.09	0.6	3,000	800	0.12	0.7	0.05
		45		2,700	850	0.1	0.5	2,700	600	0.08	0.5	2,700	750	0.12	0.7	0.03
	50	2,500		800	0.1	0.5	2,500	550	0.08	0.5	2,500	600	0.12	0.7	0.03	
	60	2,100		700	0.08	0.5	2,100	450	0.06	0.5	2,100	500	0.12	0.7	0.03	
	80	1,600		480	0.06	0.4	1,600	340	0.06	0.4	1,600	380	0.1	0.5	0.03	
	100	1,200		360	0.05	0.3	1,200	250	0.05	0.3	1,200	290	0.1	0.5	0.03	
120	1,200	360	0.05	0.3	1,200	250	0.05	0.3	1,200	290	0.1	0.5	0.03			

1. The above mentioned conditions according to projection lengths are intended as general guidelines for reference only. Adjustments should be made based on actual milling conditions.
2. Use a rigid and precise machine and holder.
3. Tool vibrations should be kept at a minimum level for maximum accuracy.
4. Under general machining condition, air-blow cutting method is recommended.
5. In the case of linear machining, do not use the ae value, instead refer to the ap value.
6. More stable high-feed machining in the corners can be attained by setting an R insertion or deceleration on the CAM or machine side.
7. When cutting load fluctuates (in the corners, etc.) or when high precision is required, be sure to control the rotational speed.
8. When cutting at greater than the recommended cutting angle, reduce the feed.
9. When the depth of cut is less than the specified amount as listed above, the feed rate can be increased up to 150%.
10. When the depth of cut is greater than the specified amount as listed above, the feed rate can be reduced by no more than 60% to ensure stable milling.

NEXT



特長
Features

ボールノーズ
Ball Nose
PHX-DFR

ボールノーズ
Ball Nose
PHX-PC-DFR

ボールノーズ
Ball Nose
PHX-LN-DFR

ボールノーズ
Ball Nose
PHX-LN-CRE

ボールノーズ
Ball Nose
PHX-DBT

ボールノーズ
Ball Nose
PHX-PC-DBT

ボールノーズ
Ball Nose
PHX-LN-DBT

ボールノーズ
Ball Nose
PHX-CRT

切削条件
Cutting Conditions

FROM

被削材 Work Material				快削材 高能率荒取り条件 ~40HRC High feed roughing of free-cutting materials		びびり抑制条件 Vibration control conditions										
						高じん性金型材 中荒取り条件 38~53HRC Semi-roughing in high toughness mold materials				仕上げ加工条件 ~55HRC Machining Conditions For Finishing						
				調質鋼・プリハードン鋼 Hardened Steel・Prehardened Steel												
				SKT4・SKD61・NAK80・HPM1・DH**				DH**・DAC**				SKT4・SKD61・NAK80・HPM1・DH**				
外径 DC	RE	首下長 LU	推奨傾斜 切込角度 Recommended Cutting Angle	回転速度 Speed (min ⁻¹)	送り速度 Feed (mm/min)	切込深さ(mm) Depth of Cut		回転速度 Speed (min ⁻¹)	送り速度 Feed (mm/min)	切込深さ(mm) Depth of Cut		回転速度 Speed (min ⁻¹)	送り速度 Feed (mm/min)	切込深さ(mm) Depth of Cut		仕上げ代 (mm) Clearance
						ap	ae			ap	ae			ap	ae	
5	R1	0.5°	10	7,700	2,500	0.2	1.2	4,800	3,600	0.2	1.2	7,700	1,800	0.12	1.2	0.1
			15	7,700	2,400	0.2	1.2	4,800	3,400	0.16	1.2	6,100	1,450	0.12	1.2	0.1
			20	7,700	2,400	0.2	1.2	4,800	3,400	0.16	1.2	6,100	1,450	0.12	1.2	0.1
			25	5,100	2,200	0.17	1	4,800	3,000	0.13	1	5,100	1,200	0.12	1.2	0.07
			30	5,100	2,200	0.17	1	4,800	3,000	0.13	1	5,100	1,200	0.12	1.2	0.07
			35	4,400	1,700	0.15	1	4,400	2,400	0.09	1	4,400	1,000	0.12	1.2	0.05
			40	3,100	1,100	0.15	1	3,100	1,500	0.08	1	3,100	750	0.12	1.2	0.05
6	R0.8	0.5°	62.3	1,900	700	0.08	0.9	1,900	700	0.08	0.9	1,900	550	0.15	1.2	0.03
			120	800	240	0.04	0.7	800	240	0.04	0.7	800	200	0.12	1	0.03
	R1		20	6,500	2,100	0.35	1.3	4,000	1,700	0.24	1.3	6,500	1,900	0.15	1.2	0.1
			40	3,700	1,500	0.15	1	3,700	1,400	0.14	1	3,700	1,100	0.15	1.2	0.07
	R1.5		24	6,500	2,100	0.35	1.3	4,000	1,700	0.24	1.3	6,500	1,900	0.15	1.2	0.1
			30	5,100	2,000	0.24	1.2	4,000	1,700	0.23	1.2	5,100	1,500	0.15	1.2	0.1
			36	4,200	1,800	0.2	1	4,000	1,700	0.19	1	4,200	1,250	0.15	1.2	0.07
			42	3,700	1,500	0.15	1	3,700	1,400	0.14	1	3,700	1,100	0.15	1.2	0.07
			48	2,600	1,000	0.13	0.9	2,600	900	0.14	0.9	2,600	800	0.15	1.2	0.05
			54	2,100	800	0.1	0.9	2,100	800	0.1	0.9	2,100	650	0.15	1.2	0.05
			66	1,900	700	0.08	0.9	1,900	700	0.08	0.9	1,900	550	0.15	1.2	0.03
			80	1,700	600	0.05	0.9	1,700	600	0.05	0.9	1,700	450	0.15	1.2	0.03
			100	1,100	330	0.04	0.7	1,100	330	0.04	0.7	1,100	260	0.12	1	0.03
			120	800	240	0.04	0.7	800	240	0.04	0.7	800	200	0.12	1	0.03
160	800	200	0.04	0.7	800	200	0.04	0.7	800	160	0.12	1	0.03			
8	R1	0.5°	63.3	1,900	880	0.2	1.3	1,900	800	0.2	1.3	1,900	700	0.18	1.6	0.05
			120.6	1,000	550	0.1	1.3	1,000	550	0.1	1.3	1,000	450	0.18	1.6	0.03
	R2		30	4,800	2,000	0.5	1.7	3,000	1,250	0.3	1.6	4,800	1,800	0.18	1.6	0.1
			40	3,800	1,900	0.4	1.6	3,000	1,250	0.3	1.6	3,800	1,400	0.18	1.6	0.1
			48	3,200	1,700	0.27	1.4	3,000	1,250	0.26	1.4	3,200	1,150	0.18	1.6	0.07
			56	2,700	1,300	0.2	1.4	2,700	1,100	0.2	1.4	2,700	1,000	0.18	1.6	0.07
			64	1,900	880	0.2	1.3	1,900	800	0.2	1.3	1,900	700	0.18	1.6	0.05
			80	1,500	700	0.15	1.3	1,500	700	0.15	1.3	1,500	550	0.18	1.6	0.03
			100	1,200	650	0.15	1.3	1,200	650	0.15	1.3	1,200	500	0.18	1.6	0.03
			120	1,000	550	0.1	1.3	1,000	550	0.1	1.3	1,000	450	0.18	1.6	0.03
160	800	360	0.1	1.3	800	360	0.1	1.3	800	300	0.18	1.6	0.03			

- 上記の突出し長別条件は目安です。実際の加工条件に合わせて調節下さい。
- 機械、ホルダは剛性の高いものをご使用下さい。
- 工具の振れ精度を最小限に抑えてご使用下さい。
- 切削油剤は被削材に適したもので、発煙性の少ないものを選択して下さい。通常エアブローを推奨致します。
- 走査線加工を行う場合は、aeの数値を使用せずに、apの数値を参考に使用して下さい。
- CAMや機械側でコーナ部のR挿入もしくは減速を設定することで、より安定した高送り加工が可能となります。
- コーナ部等切削負荷が変動する場合や加工精度を要求される場合には、回転速度を下げてください。
- 推奨傾斜切込み角度以上で加工される場合には、送り速度を下げてください。
- 切込深さが切削条件表より小さい場合、送り速度を最大150%を目安に調整して加工も可能です。
- 切込深さが切削条件表より大きくなる場合は、最大60%に減速する事で安定した加工が可能です。

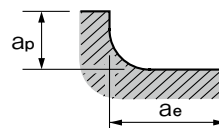

FROM

被削材 Work Material				快削材 高効率荒取り条件 ~40HRC High feed roughing of free-cutting materials				びびり抑制条件 Vibration control conditions								
				高じん性金型材 中荒取り条件 38 ~ 53HRC Semi-roughing in high toughness mold materials				仕上げ加工条件 ~55HRC Machining Conditions For Finishing								
				調質鋼・プリハードン鋼 Hardened Steel · Prehardened Steel												
				SKT4 · SKD61 · NAK80 · HPM1 · DH**				DH** · DAC**				SKT4 · SKD61 · NAK80 · HPM1 · DH**				
外径 DC	RE	首下長 LU	推奨傾斜 切込角度 Recommended Cutting Angle	回転速度 Speed (min ⁻¹)	送り速度 Feed (mm/min)	切込深さ(mm) Depth of Cut		回転速度 Speed (min ⁻¹)	送り速度 Feed (mm/min)	切込深さ(mm) Depth of Cut		回転速度 Speed (min ⁻¹)	送り速度 Feed (mm/min)	切込深さ(mm) Depth of Cut		仕上げ代 (mm) Clearance
						ap	ae			ap	ae			ap	ae	
10	R2	0.5°	35	3,800	2,100	0.5	2.5	2,400	1,000	0.3	1.6	3,800	1,500	0.2	2.4	0.1
			50	3,100	1,950	0.4	2.4	2,400	1,000	0.3	1.6	3,100	1,200	0.2	2.4	0.1
			60	2,500	1,750	0.27	2	2,400	1,000	0.27	1.6	2,500	1,000	0.2	2.4	0.1
			70	2,200	1,350	0.2	2	2,200	900	0.2	1.6	2,200	900	0.2	2.4	0.07
			80	1,500	900	0.19	2	1,500	680	0.19	1.6	1,500	600	0.2	2.4	0.07
			100	1,200	720	0.16	2	1,200	550	0.16	1.6	1,200	450	0.2	2.4	0.05
			120	1,050	650	0.13	2	1,000	500	0.13	1.6	1,050	400	0.2	2.4	0.05
			140	850	550	0.1	1.5	800	450	0.1	1.4	850	350	0.2	2.4	0.03
			160	700	500	0.07	1.5	700	400	0.07	1.4	700	300	0.2	2.4	0.03
			200	640	380	0.07	1.5	640	380	0.07	1.5	640	300	0.2	2.4	0.03
12	R2	0.5°	45	3,200	2,200	0.6	3.4	2,000	840	0.3	1.6	3,200	1,500	0.24	3.2	0.15
			60	2,500	2,100	0.5	3.2	2,000	840	0.3	1.6	2,500	1,200	0.24	3.2	0.15
			70	2,100	1,900	0.4	2.8	2,000	840	0.28	1.6	2,100	1,000	0.24	3.2	0.1
			85	1,800	1,500	0.3	2.7	1,500	630	0.22	1.6	1,800	870	0.24	3.2	0.1
			100	1,300	1,000	0.2	2.6	1,200	500	0.2	1.6	1,300	630	0.24	3.2	0.1
			120	1,000	700	0.15	2.5	1,000	500	0.15	1.6	1,000	480	0.24	3.2	0.05
			140	900	600	0.15	2	900	400	0.1	1.6	900	440	0.24	3.2	0.05
			160	700	500	0.1	2	700	400	0.1	1.6	700	380	0.24	3.2	0.05
16	R3	0.5°	55	2,400	2,000	0.5	4.2	1,500	630	0.3	1.6	2,400	1,350	0.3	4	0.2
			80	1,900	1,900	0.47	4	1,500	630	0.3	1.6	1,900	1,100	0.3	4	0.15
			90	1,600	1,700	0.4	3.4	1,500	630	0.3	1.6	1,600	900	0.3	4	0.1
			105	1,400	1,300	0.29	3.3	1,400	580	0.28	1.6	1,400	800	0.3	4	0.07
			120	1,000	850	0.2	3.2	1,000	450	0.2	1.6	1,000	600	0.3	4	0.05
20	R3	0.5°	70	1,900	2,000	0.5	5.5	1,200	500	0.3	1.6	1,900	1,550	0.42	5.5	0.2
			90	1,500	1,900	0.47	5.3	1,200	500	0.3	1.6	1,500	1,200	0.42	5.5	0.15
			110	1,300	1,700	0.42	4.2	1,200	500	0.3	1.6	1,300	1,050	0.42	5.5	0.1
			130	1,100	1,300	0.31	3.8	1,100	450	0.3	1.6	1,100	900	0.42	5.5	0.07
			150	760	870	0.25	3.4	760	350	0.23	1.6	760	600	0.42	5.5	0.05

1. The above mentioned conditions according to projection lengths are intended as general guidelines for reference only. Adjustments should be made based on actual milling conditions.
2. Use a rigid and precise machine and holder.
3. Tool vibrations should be kept at a minimum level for maximum accuracy.
4. Under general machining condition, air-blow cutting method is recommended.
5. In the case of linear machining, do not use the ae value, instead refer to the ap value.
6. More stable high-feed machining in the corners can be attained by setting an R insertion or deceleration on the CAM or machine side.
7. When cutting load fluctuates (in the corners, etc.) or when high precision is required, be sure to control the rotational speed.
8. When cutting at greater than the recommended cutting angle, reduce the feed.
9. When the depth of cut is less than the specified amount as listed above, the feed rate can be increased up to 150%.
10. When the depth of cut is greater than the specified amount as listed above, the feed rate can be reduced by no more than 60% to ensure stable milling.



特長 Features
 Bull Nose
 PHX-DFR
 Bull Nose
 PHX-PC-DFR
 Bull Nose
 PHX-LN-DFR
 Bull Nose
 PHX-LN-CRE
 Bull Nose
 PHX-LN-DBT
 Bull Nose
 PHX-PC-DBT
 Bull Nose
 PHX-LN-DBT
 Bull Nose
 PHX-CRT

被削材 Work Material			リブ溝切削 Lib Groove Milling								等高線仕上げ切削 Contour Line Finishing		
			溝 Slotting				等高オフセット Contour Offset						
			CENA1, STAVAX, HPM38, SKD61 42 ~ 55HRC										
外径 DC	RE	首下長 LU	回転速度 Speed (min ⁻¹)	送り速度 Feed (mm/min)	切込深さ (mm) Depth of Cut		回転速度 Speed (min ⁻¹)	送り速度 Feed (mm/min)	切込深さ (mm) Depth of Cut		回転速度 Speed (min ⁻¹)	送り速度 Feed (mm/min)	切込深さ (mm) Depth of Cut ae
					ap	ae			ap	ae			
0.8	0.1	2	18,000	720	0.02	0.2	18,000	930	0.02	0.2	18,000	1,150	0.015
		4	18,000	720	0.02	0.2	18,000	930	0.02	0.2	18,000	1,150	0.015
		6	18,000	720	0.02	0.2	18,000	930	0.02	0.2	18,000	1,150	0.015
		8	15,000	540	0.013	0.2	15,000	630	0.013	0.2	16,000	700	0.013
1	0.1	4	18,000	830	0.03	0.23	18,000	880	0.03	0.23	18,000	1,440	0.015
		6	18,000	830	0.024	0.23	18,000	880	0.024	0.23	18,000	1,440	0.015
		8	15,000	750	0.013	0.23	15,000	800	0.013	0.23	15,000	1,200	0.015
		10	12,000	300	0.007	0.2	12,000	400	0.007	0.2	12,000	960	0.015
		12	10,500	220	0.006	0.18	10,500	288	0.006	0.18	10,500	840	0.015
1	0.2	4	18,000	830	0.03	0.23	18,000	880	0.03	0.23	18,000	1,440	0.018
		6	18,000	830	0.024	0.23	18,000	880	0.024	0.23	18,000	1,440	0.018
		8	15,000	750	0.013	0.23	15,000	800	0.013	0.23	15,000	1,200	0.018
		10	12,000	300	0.007	0.2	12,000	400	0.007	0.2	12,000	960	0.018
		12	10,500	220	0.006	0.18	10,500	290	0.006	0.18	10,500	840	0.018
1	0.3	4	18,000	830	0.03	0.23	18,000	1,000	0.03	0.23	18,000	1,440	0.022
		6	18,000	830	0.024	0.23	18,000	890	0.024	0.23	18,000	1,440	0.022
1.5	0.1	4	16,000	1,230	0.03	0.34	16,000	1,300	0.03	0.34	18,000	1,620	0.015
		8	16,000	1,230	0.026	0.34	16,000	1,300	0.026	0.34	18,000	1,620	0.015
		12	10,000	480	0.013	0.3	10,000	750	0.013	0.3	10,000	900	0.015
1.5	0.2	4	16,000	1,230	0.03	0.34	16,000	1,300	0.03	0.34	18,000	1,620	0.018
		6	16,000	1,230	0.029	0.34	16,000	1,300	0.029	0.34	18,000	1,620	0.018
		8	16,000	1,230	0.026	0.34	16,000	1,300	0.026	0.34	18,000	1,620	0.018
2	0.1	8	12,000	1,300	0.03	0.46	12,000	1,760	0.03	0.46	18,000	1,620	0.015
		10	12,000	1,200	0.03	0.46	12,000	1,620	0.03	0.46	15,000	1,350	0.015
		12	12,000	1,150	0.024	0.46	12,000	1,320	0.024	0.46	13,000	1,170	0.015
		16	7,600	780	0.012	0.46	7,600	750	0.012	0.46	7,000	630	0.015
2	0.3	8	12,000	1,300	0.05	0.46	12,000	1,620	0.05	0.46	18,000	1,620	0.022
		12	12,000	1,150	0.04	0.46	12,000	1,320	0.04	0.46	13,000	1,170	0.022
2	0.5	6	12,000	1,300	0.08	0.45	12,000	1,760	0.08	0.45	18,000	1,620	0.025
		8	12,000	1,300	0.075	0.45	12,000	1,760	0.075	0.45	18,000	1,620	0.025
		10	12,000	1,200	0.07	0.45	12,000	1,620	0.07	0.45	15,000	1,350	0.025
		12	12,000	1,150	0.06	0.45	12,000	1,320	0.06	0.45	13,000	1,170	0.025
3	0.3	12	8,000	1,200	0.046	0.7	8,000	1,400	0.046	0.7	13,000	1,170	0.022

- 加工形状、機械剛性、ホルダ剛性、ワーク保持力等の使用状況により、回転速度、送り速度、切込深さを調節下さい。
- 回転速度、送り速度が機械性能によって上がらない場合は、回転速度、送り速度を同じ比率で下げてください。
- 高い切削速度や高い送り速度は、工具の消耗や加工精度を落とす原因となります。必要に応じて送り速度を下げてください。
- 加工形状によって加工時にびびりが発生する場合は、形状の食い込みなどの原因となる為、回転速度と送り速度を同じ比率で下げて調節下さい。
- 精密、精細加工は静粛性に優れた専用加工機をご使用下さい。
- 加工時は工具刃先の振れを0.005mm以下に抑えてご使用下さい。
- 仕上げ加工の高効率加工を行う場合、回転速度、送り速度は2倍を上限に調節下さい。
- 平面を仕上げる場合は、機械の振動が少ない回転域で使用し、送り速度による機械のブレが起こらないように加工下さい。
- 工具コーナー半径で曲面形状の仕上げ加工を行う場合は、加工ピッチ（カスプハイトを考慮した）を変えてご使用下さい。
- 傾斜切込み角度は、0.3° ~ 0.5°を目安に設定して下さい。
- 切込深さが切削条件表より小さい場合、送り速度を最大150%を目安に調整して加工も可能です。
- 切込深さが切削条件表より大きくなる場合は、最大60%に減速する事で安定した加工が可能です。

- Adjust the speed, feed, and depth of cut in according to the operating conditions, including the machining shape, machine and, holder rigidity, and workholding force.
- If the speed and feed rates cannot be increased due to equipment capability, operate by reducing the speed and feed rates at the same ratio.
- High cutting speeds and feed rates can cause wear and/or reduce machining precision. Therefore, please reduce the feed as needed.
- Chattering may occur depending on the shape of the part, which can damages. Reduce the speed and feed rate at the same ratio to avoid chattering.
- For precise, detailed machining, use a dedicated machine that operates less chattering.
- Keep the runout at the tip of the end mill below 0.005mm.
- To perform finish machining with a high level of efficiency, keep the speed and feed rates below 2 times.
- To finish a flat surface, remain speed range in a minimal amount of equipment vibration and feed rate not causing the equipment to wobble.
- To finish machining a curved surface using the corner radius of the tool, operate by changing the machining pitch.
- Set the inclined cut angle between approximately 0.3° to 0.5°
- When the depth of cut is less than the specified amount as listed above, the feed rate can be increased up to 150%.
- When the depth of cut is greater than the specified amount as listed above, the feed rate can be reduced by no more than 60% to ensure stable milling.



被削材 Work Material		快削材 高効率荒取り条件 ~40HRC High feed roughing of free-cutting materials		びびり抑制条件 Vibration control conditions															
		高じん性金型材 中荒取り条件 38~53HRC Semi-roughing in high toughness mold materials				溝加工条件 ~53HRC Machining Conditions For Slotting				仕上げ加工条件 ~55HRC Machining Conditions For Finishing									
		調質鋼・プリハードン鋼 Hardened Steel・Prehardened Steel																	
		SKT4・SKD61・NAK80・HPM1・DH**				DH**・DAC**				SKT4・SKD61・NAK80・HPM1・DH**				SKT4・SKD61・NAK80・HPM1・DH**					
RE	首下長 LU	推奨傾斜 切込角度 Recommended Cutting Angle	回転速度 Speed (min ⁻¹)	送り速度 Feed (mm/min)	切込深さ(mm) Depth of Cut		回転速度 Speed (min ⁻¹)	送り速度 Feed (mm/min)	切込深さ(mm) Depth of Cut		回転速度 Speed (min ⁻¹)	送り速度 Feed (mm/min)	切込深さ(mm) Depth of Cut		回転速度 Speed (min ⁻¹)	送り速度 Feed (mm/min)	切込深さ(mm) Depth of Cut		仕上げ代 Clearance (mm)
					a _p	P _f			a _p	P _f			a _p	P _f			a _p	P _f	
R0.5	0.3°	6	18,000	1,000	0.05	0.16	18,000	900	0.05	0.16	18,000	280	0.007	0.03	18,000	1,200	0.03	0.03	0.05
		10	16,000	800	0.04	0.16	16,000	800	0.04	0.16	16,000	120	0.003	0.3	16,000	1,000	0.03	0.03	0.03
		15	8,000	420	0.03	0.16	8,000	420	0.03	0.16	-	-	-	-	8,000	500	0.03	0.03	0.03
		20	6,000	300	0.02	0.12	6,000	300	0.02	0.12	-	-	-	-	6,000	380	0.03	0.03	0.03
		25	6,000	130	0.02	0.08	6,000	130	0.02	0.08	-	-	-	-	6,000	350	0.03	0.03	0.03
		30	6,000	90	0.01	0.05	6,000	90	0.01	0.05	-	-	-	-	6,000	250	0.03	0.03	0.03
		35	6,000	90	0.01	0.05	6,000	90	0.01	0.05	-	-	-	-	6,000	250	0.03	0.03	0.03
		40	4,800	45	0.007	0.02	4,800	45	0.007	0.02	-	-	-	-	4,800	140	0.03	0.03	0.03
		50	4,800	45	0.007	0.02	4,800	45	0.007	0.02	-	-	-	-	4,800	140	0.03	0.03	0.03
		60	4,800	30	0.005	0.015	4,800	30	0.005	0.015	-	-	-	-	4,800	90	0.03	0.03	0.03
R0.75	0.3°	6	18,000	1,500	0.1	0.3	16,000	1,300	0.1	0.3	16,000	650	0.07	0.15	18,000	1,100	0.04	0.04	0.05
		10	15,000	1,100	0.06	0.25	15,000	950	0.06	0.25	15,000	320	0.01	0.1	15,000	900	0.04	0.04	0.03
		16	7,500	230	0.02	0.2	7,500	200	0.02	0.2	7,500	300	0.007	0.05	7,500	450	0.04	0.04	0.03
		20	5,300	130	0.02	0.2	5,300	130	0.02	0.2	6,300	200	0.007	0.05	5,300	250	0.04	0.04	0.03
		25	5,300	130	0.02	0.2	5,300	130	0.02	0.2	-	-	-	-	5,300	250	0.04	0.04	0.03
		30	4,200	60	0.01	0.15	4,200	60	0.01	0.15	-	-	-	-	4,200	100	0.04	0.04	0.03
		40	4,200	60	0.01	0.15	4,200	60	0.01	0.15	-	-	-	-	4,200	100	0.04	0.03	0.02
		50	4,200	60	0.01	0.15	4,200	60	0.01	0.15	-	-	-	-	4,200	100	0.04	0.03	0.02

1. 上記の突出し量別条件は目安です。実際の加工条件に合わせて調節下さい。
2. R0.5 ~ R2.5までは標準状態での首元でチャッキングした工具突出し加工条件です。
3. 機械、ホルダは剛性の高いものをご使用下さい。
4. 工具の振れ精度を最小限に抑えてご使用下さい。
5. 走査線加工を行う場合は、P_fの数値を使用せずに、a_pの数値を参考にご使用下さい。
6. CAMや機械側でコーナー部のR挿入もしくは減速を設定することで、より安定した高送り加工が可能となります。
7. コーナ部等切削負荷が変動する場合や加工精度を要求される場合には、回転速度を抑えてご使用下さい。
8. 推奨傾斜切込み角度以上で加工される場合には、送り速度を下げてご使用下さい。
9. 切込深さが切削条件表より小さい場合、送り速度を最大150%を目安に調整して加工も可能です。
10. 切込深さが切削条件表より大きくなる場合は、最大60%に減速する事で安定した加工が可能です。

1. The above mentioned conditions according to projection lengths are intended as general guidelines for reference only. Adjustments should be made based on actual milling conditions.
2. For 0.5R-2.5R, the machining conditions are based on chucking the tool up to the base of the neck.
3. Use a rigid and precise machine and holder.
4. Tool vibrations should be kept at a minimum level for maximum accuracy.
5. In the case of linear machining, do not use the P_f value, instead refer to the a_p value.
6. More stable high-feed machining in the corners can be attained by setting an R insertion or deceleration on the CAM or machine side.
7. When cutting load fluctuates (in the corners, etc.) or when high precision is required, be sure to control the rotational speed.
8. When cutting at greater than the recommended cutting angle, reduce the feed.
9. When the depth of cut is less than the specified amount as listed above, the feed rate can be increased up to 150%.
10. When the depth of cut is greater than the specified amount as listed above, the feed rate can be reduced by no more than 60% to ensure stable milling.

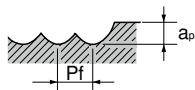

ボールエンドミルをご使用の場合、「同工具径の」ラジウスエンドミルと比較して、前カッタパス(LAST PITCHがない状態)における削り残しが(コーナーR部の大きさによる切削抵抗による工具の倒れが大きいため、荒削り残し補正パス)・仕上げ加工の2回(右の図の2重線の様に)に分けて等高線加工をする事によってリブ溝の「加工」精度を上げることができます。In comparison to the same tool diameters of radius end mill, ball end mill machine less material per pass (large corner radius generate cutting resistance which tilt ball end mill largely). In order to improve the precision of the ribs, please separate the contour milling in roughing (correction of unmachined area) and finishing (shown as double lined area in figure on right) procedure.

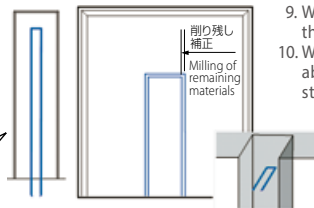

FROM

被削材 Work Material		快削材 高能率荒取り条件 ~40HRC High feed roughing of free-cutting materials				高じん性金型材 中荒取り条件 38~53HRC Semi-roughing in high toughness mold materials				びびり抑制条件 Vibration control conditions 溝加工条件 ~53HRC Machining Conditions For Slotting				仕上げ加工条件 ~55HRC Machining Conditions For Finishing							
		調質鋼・プリハードン鋼 Hardened Steel・Prehardened Steel																			
		SKT4・SKD61・NAK80・HPM1・DH**				DH**・DAC**				SKT4・SKD61・NAK80・HPM1・DH**				SKT4・SKD61・NAK80・HPM1・DH**							
RE	首下長 LU	推奨傾斜 切込角度 Recommended Cutting Angle	回転速度 Speed (min ⁻¹)		送り速度 Feed (mm/min)		切込深さ(mm) Depth of Cut		回転速度 Speed (min ⁻¹)		送り速度 Feed (mm/min)		切込深さ(mm) Depth of Cut		回転速度 Speed (min ⁻¹)		送り速度 Feed (mm/min)		切込深さ(mm) Depth of Cut		仕上げ代 (mm) Clearance
			a _p	Pf	a _p	Pf	a _p	Pf	a _p	Pf	a _p	Pf	a _p	Pf	a _p	Pf					
R1	6	0.3°	18,000	1,600	0.2	0.6	15,000	1,400	0.2	0.4	12,000	600	0.15	0.15	15,000	1,800	0.06	0.05	0.1		
	10		12,000	1,250	0.14	0.4	12,000	1,100	0.14	0.4	12,000	600	0.1	0.05	12,000	1,500	0.06	0.05	0.07		
	15		7,800	820	0.14	0.4	7,800	780	0.14	0.4	7,800	450	0.07	0.05	7,800	980	0.06	0.05	0.07		
	20		6,200	650	0.13	0.4	6,200	600	0.13	0.3	6,200	340	0.05	0.05	6,200	600	0.06	0.05	0.05		
	25		4,700	500	0.12	0.3	4,700	500	0.12	0.3	-	-	-	-	4,700	450	0.06	0.05	0.05		
	30		3,500	400	0.1	0.3	3,500	400	0.1	0.3	-	-	-	-	3,500	450	0.06	0.05	0.05		
	35		3,500	400	0.07	0.3	3,500	400	0.07	0.3	-	-	-	-	3,500	450	0.06	0.05	0.03		
	40		3,500	300	0.07	0.25	3,500	300	0.07	0.25	-	-	-	-	3,500	450	0.06	0.05	0.03		
	45		3,500	200	0.07	0.2	3,500	200	0.07	0.2	-	-	-	-	3,500	450	0.06	0.05	0.03		
	50		3,500	150	0.06	0.1	3,500	150	0.06	0.1	-	-	-	-	3,500	450	0.06	0.05	0.03		
60	3,500	150	0.05	0.1	3,500	150	0.05	0.1	-	-	-	-	3,500	450	0.06	0.05	0.03				
R1.25	16	0.3°	10,200	1,070	0.16	0.5	10,200	1,070	0.16	0.5	10,200	750	0.08	0.07	10,200	1,500	0.07	0.06	0.1		
	20		10,200	920	0.16	0.5	10,200	920	0.16	0.5	10,200	650	0.05	0.05	10,200	1,500	0.07	0.06	0.07		
	30		5,100	460	0.12	0.5	5,100	460	0.12	0.5	5,100	350	0.03	0.03	5,100	700	0.07	0.06	0.07		
	40		5,100	460	0.1	0.4	5,100	460	0.1	0.4	-	-	-	-	5,100	700	0.07	0.06	0.05		
	50		2,500	150	0.06	0.3	2,500	150	0.06	0.3	-	-	-	-	2,500	300	0.06	0.05	0.03		
	60		1,900	110	0.04	0.3	1,900	110	0.04	0.3	-	-	-	-	1,900	200	0.06	0.05	0.03		
80	1,900	110	0.04	0.3	1,900	110	0.04	0.3	-	-	-	-	1,900	200	0.06	0.05	0.03				
R1.5	10	0.3°	12,000	1,900	0.21	0.5	8,000	1,200	0.21	0.5	8,000	700	0.13	0.1	11,000	2,050	0.09	0.08	0.1		
	15		10,000	1,550	0.2	0.5	8,000	1,200	0.2	0.5	8,000	550	0.1	0.1	10,000	1,900	0.09	0.08	0.07		
	20		7,500	1,150	0.19	0.5	7,200	1,100	0.19	0.5	7,200	480	0.06	0.07	7,500	1,400	0.09	0.08	0.07		
	25		4,800	750	0.19	0.5	4,600	700	0.19	0.5	4,600	320	0.04	0.05	4,800	900	0.09	0.08	0.05		
	30		4,000	630	0.16	0.4	3,400	500	0.16	0.4	3,400	240	0.02	0.03	3,800	720	0.09	0.08	0.03		
	40		2,800	440	0.13	0.4	2,600	400	0.13	0.4	-	-	-	-	2,600	500	0.09	0.08	0.03		
	50		2,200	350	0.1	0.4	2,200	300	0.1	0.4	-	-	-	-	2,200	400	0.09	0.08	0.03		
	60		2,200	350	0.07	0.4	2,200	300	0.07	0.4	-	-	-	-	2,200	400	0.09	0.08	0.03		
	70		2,100	250	0.07	0.4	2,100	210	0.07	0.4	-	-	-	-	2,100	270	0.09	0.08	0.03		
90	2,100	250	0.05	0.3	2,100	210	0.05	0.3	-	-	-	-	2,100	270	0.07	0.06	0.03				

- 上記の突出し量別条件は目安です。実際の加工条件に合わせて調節下さい。
- R0.5 ~ R2.5までは標準状態での首元でチャッキングした工具突出し加工条件です。
- 機械、ホルダは剛性の高いものをご使用下さい。
- 工具の振れ精度を最小限に抑えてご使用下さい。
- 走査線加工を行う場合は、Pfの数値を使用せずに、a_pの数値を参考にしてください。
- CAMや機械側でコーナ部のR挿入もしくは減速を設定することで、より安定した高送り加工が可能となります。
- コーナ部等切削負荷が変動する場合や加工精度を要求される場合には、回転速度を抑えてご使用下さい。
- 推奨傾斜切込み角度以上で加工される場合には、送り速度を下げてください。
- 切込深さが切削条件表より小さい場合、送り速度を最大150%を目安に調整して加工も可能です。
- 切込深さが切削条件表より大きくなる場合は、最大60%に減速する事で安定した加工が可能です。

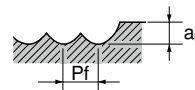

ボールエンドミルをご使用の場合、「同工具径の」ラジウスエンドミルと比較して、前カッタパス(LAST PITCHがない状態)における削り残しが(コーナーR部の大きさによる切削抵抗による工具の倒れが大きい)多いため、荒削り残し補正(パス)・仕上げ加工の2回(右の図の2重線の様)に分けて等高線加工をする事によってリブ溝の「加工」精度を上げることができます。
 In comparison to the same tool diameters of radius end mill, ball end mill machine less material per pass (large corner radius generate cutting resistance which tilt ball end mill largely). In order to improve the precision of the ribs, please separate the contour milling in roughing (correction of unmachined area) and finishing (shown as double lined area in figure on right) procedure.

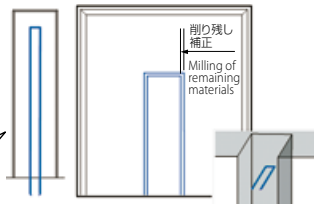

NEXT



FROM

被削材 Work Material		びびり抑制条件 Vibration control conditions																	
		快削材 高効率荒取り条件 ~40HRC High feed roughing of free-cutting materials				高じん性金型材 中荒取り条件 38 ~ 53HRC Semi-roughing in high toughness mold materials				溝加工条件 ~53HRC Machining Conditions For Slotting				仕上げ加工条件 ~55HRC Machining Conditions For Finishing					
		調質鋼・プリハードン鋼 Hardened Steel・Prehardened Steel																	
RE	首下長 LU	推奨傾斜 切込角度 Recommended Cutting Angle	SKT4・SKD61・NAK80・HPM1・DH**				DH***・DAC**				SKT4・SKD61・NAK80・HPM1・DH**				SKT4・SKD61・NAK80・HPM1・DH**				
			回転速度 Speed (min ⁻¹)	送り速度 Feed (mm/min)	切込深さ(mm) Depth of Cut		回転速度 Speed (min ⁻¹)	送り速度 Feed (mm/min)	切込深さ(mm) Depth of Cut		回転速度 Speed (min ⁻¹)	送り速度 Feed (mm/min)	切込深さ(mm) Depth of Cut		回転速度 Speed (min ⁻¹)	送り速度 Feed (mm/min)	切込深さ(mm) Depth of Cut		仕上げ代 Clearance (mm)
			a _p	P _f	a _p	P _f	a _p	P _f	a _p	P _f	a _p	P _f	a _p	P _f	a _p	P _f			
R1.75	20	0.5°	7,280	1,310	0.22	0.5	6,370	960	0.22	0.5	6,370	570	0.08	0.07	8,190	1,720	0.1	0.09	0.08
	30		4,550	820	0.18	0.5	3,640	550	0.18	0.5	3,640	330	0.02	0.03	5,000	1,050	0.1	0.09	0.03
	40		3,180	570	0.13	0.5	2,730	410	0.13	0.5	-	-	-	-	2,730	570	0.1	0.09	0.04
	50		2,730	500	0.1	0.4	2,280	340	0.1	0.4	-	-	-	-	2,280	480	0.1	0.08	0.03
	60		2,280	410	0.07	0.4	2,280	340	0.07	0.4	-	-	-	-	2,280	480	0.1	0.08	0.03
	80		1,820	330	0.06	0.3	1,820	270	0.06	0.3	-	-	-	-	1,820	380	0.1	0.07	0.03
	100		1,820	330	0.06	0.3	1,820	270	0.06	0.3	-	-	-	-	1,820	380	0.1	0.07	0.03
R2	10	0.5°	9,600	2,000	0.3	0.6	6,000	1,250	0.3	0.6	6,000	800	0.15	0.1	9,500	2,400	0.12	0.1	0.1
	15		9,300	1,900	0.27	0.6	6,000	1,200	0.27	0.6	6,000	800	0.12	0.1	9,000	2,250	0.12	0.1	0.1
	20		7,600	1,550	0.25	0.6	6,000	1,150	0.25	0.6	6,000	700	0.1	0.07	8,200	2,050	0.12	0.1	0.1
	25		6,100	1,250	0.23	0.6	5,500	1,100	0.23	0.6	5,500	450	0.05	0.07	5,500	1,350	0.12	0.1	0.07
	30		5,000	1,050	0.2	0.6	4,500	800	0.2	0.6	4,500	350	0.03	0.05	4,500	1,100	0.12	0.1	0.07
	35		3,600	750	0.16	0.5	3,600	650	0.16	0.5	3,600	280	0.01	0.03	3,600	900	0.12	0.1	0.05
	40		3,000	630	0.12	0.5	3,000	550	0.12	0.5	3,000	150	0.007	0.01	3,000	750	0.12	0.1	0.05
	45		2,700	550	0.1	0.4	2,700	500	0.1	0.4	-	-	-	-	2,700	680	0.12	0.1	0.03
	50		2,500	520	0.1	0.4	2,500	450	0.1	0.4	-	-	-	-	2,500	630	0.12	0.1	0.03
	60		2,100	430	0.08	0.4	2,100	400	0.08	0.4	-	-	-	-	2,100	530	0.12	0.1	0.03
	70		1,600	240	0.08	0.4	1,600	220	0.08	0.4	-	-	-	-	1,600	280	0.12	0.1	0.03
	90		1,600	240	0.08	0.4	1,600	220	0.08	0.4	-	-	-	-	1,600	280	0.12	0.1	0.03
	100		1,600	240	0.07	0.3	1,600	220	0.07	0.3	-	-	-	-	1,600	280	0.1	0.08	0.03
	120		1,200	140	0.05	0.3	1,200	130	0.05	0.3	-	-	-	-	1,200	170	0.1	0.08	0.03
	150		1,200	140	0.05	0.3	1,200	130	0.05	0.3	-	-	-	-	1,200	170	0.1	0.08	0.03
R2.5	10	0.5°	7,700	1,900	0.35	0.8	4,800	1,100	0.35	0.8	4,800	900	0.2	0.1	7,700	2,400	0.15	1.2	0.1
	15		7,700	1,900	0.3	0.8	4,800	1,000	0.3	0.8	4,800	850	0.16	0.1	6,100	1,900	0.15	1.2	0.1
	20		7,700	1,800	0.3	0.8	4,800	950	0.3	0.8	4,800	700	0.12	0.07	6,100	1,900	0.15	1.2	0.1
	25		5,100	1,300	0.25	0.8	4,800	900	0.25	0.8	4,800	650	0.06	0.05	5,100	1,600	0.15	1.2	0.07
	30		5,100	1,200	0.2	0.6	4,800	850	0.2	0.6	4,800	500	0.03	0.05	5,100	1,600	0.15	1.2	0.07
	35		4,400	1,100	0.14	0.6	4,400	750	0.14	0.6	4,400	400	0.015	0.03	4,400	1,350	0.15	1.2	0.05
	40		3,100	750	0.1	0.6	3,100	650	0.1	0.6	3,100	260	0.007	0.03	3,100	950	0.15	1.2	0.05
	60		2,200	430	0.1	0.6	2,200	400	0.08	0.5	-	-	-	-	2,200	600	0.15	1.2	0.05
	80		1,600	250	0.1	0.5	1,600	240	0.08	0.5	-	-	-	-	1,600	430	0.15	1.2	0.05
	90		1,600	250	0.1	0.5	1,600	240	0.08	0.5	-	-	-	-	1,600	430	0.15	1.2	0.05

- The above mentioned conditions according to projection lengths are intended as general guidelines for reference only. Adjustments should be made based on actual milling conditions.
- For 0.5R-2.5R, the machining conditions are based on chucking the tool up to the base of the neck.
- Use a rigid and precise machine and holder.
- Tool vibrations should be kept at a minimum level for maximum accuracy.
- In the case of linear machining, do not use the P_f value, instead refer to the a_p value.
- More stable high-feed machining in the corners can be attained by setting an R insertion or deceleration on the CAM or machine side.
- When cutting load fluctuates (in the corners, etc.) or when high precision is required, be sure to control the rotational speed.
- When cutting at greater than the recommended cutting angle, reduce the feed.
- When the depth of cut is less than the specified amount as listed above, the feed rate can be increased up to 150%.
- When the depth of cut is greater than the specified amount as listed above, the feed rate can be reduced by no more than 60% to ensure stable milling.

NEXT



特長
Features

ボールノーズ
Ball Nose
PHX-DFR

ボールノーズ
Ball Nose
PHX-PC-DFR

ボールノーズ
Ball Nose
PHX-LN-DFR

ボールノーズ
Ball Nose
PHX-LN-CRE

ボールノーズ
Ball Nose
PHX-DBT

ボールノーズ
Ball Nose
PHX-PC-DBT

ボールノーズ
Ball Nose
PHX-LN-DBT

ボールノーズ
Ball Nose
PHX-CRT

切削条件
Cutting Conditions

FROM

被削材 Work Material		快削材 高能率荒取り条件 ~40HRC High feed roughing of free-cutting materials				高じん性金型材 中荒取り条件 38~53HRC Semi-roughing in high toughness mold materials				びびり抑制条件 Vibration control conditions				溝加工条件 ~53HRC Machining Conditions For Slotting				仕上げ加工条件 ~55HRC Machining Conditions For Finishing			
		調質鋼・プリハードン鋼 Hardened Steel・Prehardened Steel																			
		SKT4・SKD61・NAK80・HPM1・DH**				DH**・DAC**				SKT4・SKD61・NAK80・HPM1・DH**				SKT4・SKD61・NAK80・HPM1・DH**							
RE	首下長 LU	推奨傾斜 切込角度 Recommended Cutting Angle	回転速度 Speed (min ⁻¹)	送り速度 Feed (mm/min)	切込深さ(mm) Depth of Cut		回転速度 Speed (min ⁻¹)	送り速度 Feed (mm/min)	切込深さ(mm) Depth of Cut		回転速度 Speed (min ⁻¹)	送り速度 Feed (mm/min)	切込深さ(mm) Depth of Cut		回転速度 Speed (min ⁻¹)	送り速度 Feed (mm/min)	切込深さ(mm) Depth of Cut		仕上げ代 (mm) Clearance		
					ap	Pf			ap	Pf			ap	Pf			ap	Pf			
R3	24	0.5°	6,400	1,900	0.43	1.2	4,000	1,200	0.3	1	4,000	900	0.3	0.1	6,500	1,950	0.18	0.16	0.1		
	30		5,100	1,500	0.34	1.2	4,000	1,150	0.3	1	4,000	900	0.25	0.1	5,100	1,950	0.18	0.16	0.1		
	36		4,200	1,250	0.38	1.2	4,000	1,100	0.3	1	4,000	750	0.2	0.07	4,200	1,580	0.18	0.16	0.07		
	42		3,700	1,050	0.2	0.9	3,700	1,000	0.2	1	3,700	500	0.15	0.05	3,700	1,400	0.18	0.16	0.07		
	48		3,600	750	0.15	0.9	2,600	700	0.15	0.8	2,600	400	0.1	0.03	2,600	980	0.18	0.16	0.05		
	54		2,100	630	0.1	0.8	2,100	600	0.1	0.8	2,100	240	0.05	0.03	2,100	800	0.18	0.16	0.05		
	66		1,900	550	0.08	0.7	1,900	500	0.08	0.7	-	-	-	-	1,900	700	0.18	0.16	0.03		
	80		1,700	450	0.08	0.6	1,700	400	0.08	0.6	-	-	-	-	1,700	650	0.18	0.16	0.03		
	90		1,600	380	0.08	0.6	1,600	380	0.08	0.6	-	-	-	-	1,600	580	0.18	0.16	0.03		
	120		1,300	280	0.08	0.5	1,300	280	0.07	0.4	-	-	-	-	1,300	460	0.15	0.13	0.03		
150	1,300	280	0.08	0.5	1,300	280	0.07	0.4	-	-	-	-	1,300	460	0.15	0.13	0.03				
R4	30	0.5°	4,800	2,300	0.45	1.5	3,000	1,260	0.3	1.5	3,000	1,050	0.3	0.15	4,800	2,400	0.24	0.21	0.1		
	40		3,800	1,800	0.38	1.3	3,000	1,200	0.3	1.3	3,000	1,050	0.3	0.1	3,800	1,900	0.24	0.21	0.1		
	48		3,200	1,500	0.28	1.2	3,000	1,100	0.25	1.2	3,000	900	0.25	0.1	3,200	1,600	0.24	0.21	0.07		
	56		2,700	1,300	0.2	1.1	2,700	1,000	0.2	1.1	2,700	800	0.2	0.07	2,700	1,350	0.24	0.21	0.07		
	64		1,900	900	0.2	1	1,900	700	0.17	1	1,900	500	0.17	0.07	1,900	950	0.24	0.21	0.05		
	80		1,500	700	0.15	0.8	1,500	550	0.14	0.8	-	-	-	-	1,500	750	0.24	0.21	0.03		
	90		1,400	670	0.15	0.8	1,400	500	0.12	0.8	-	-	-	-	1,400	700	0.24	0.21	0.03		
	100		1,200	600	0.15	0.8	1,200	400	0.1	0.8	-	-	-	-	1,200	600	0.24	0.21	0.03		
120	1,000	500	0.1	0.7	1,000	350	0.07	0.7	-	-	-	-	1,000	500	0.24	0.21	0.03				
R5	35	0.5°	3,800	2,300	0.65	1.8	2,400	1,000	0.4	1.6	2,400	850	0.4	0.15	3,800	2,400	0.3	0.27	0.1		
	50		3,100	1,900	0.55	1.8	2,400	1,000	0.3	1.6	2,400	850	0.3	0.15	3,100	1,950	0.3	0.27	0.1		
	60		2,500	1,500	0.46	1.6	2,400	1,000	0.3	1.5	2,400	850	0.3	0.1	2,500	1,550	0.3	0.27	0.1		
	70		2,200	1,300	0.34	1.6	2,200	900	0.3	1.5	2,200	800	0.3	0.1	2,200	1,350	0.3	0.27	0.07		
	80		1,500	800	0.24	1.6	1,500	600	0.2	1.5	1,500	600	0.2	0.07	1,500	950	0.3	0.27	0.07		
	100		1,200	600	0.15	1.5	1,200	500	0.12	1.5	1,200	500	0.12	0.07	1,200	750	0.3	0.27	0.05		
	120		1,050	500	0.1	1.3	1,000	400	0.1	1.3	-	-	-	-	1,050	650	0.3	0.27	0.05		
	140		850	400	0.07	1.3	800	350	0.07	1.3	-	-	-	-	850	500	0.3	0.27	0.03		
160	700	320	0.07	1	700	300	0.07	1	-	-	-	-	700	450	0.3	0.27	0.03				

- 上記の突出し量別条件は目安です。実際の加工条件に合わせて調節下さい。
- R0.5 ~ R2.5までは標準状態での首元でチャッキングした工具突出し加工条件です。
- 機械、ホルダは剛性の高いものをご使用下さい。
- 工具の振れ精度を最小限に抑えてご使用下さい。
- 走査線加工を行う場合は、Pfの数値を使用せずに、apの数値を参考に使用下さい。
- CAMや機械側でコーナー部のR挿入もしくは減速を設定することで、より安定した高送り加工が可能となります。
- コーナー部等切削負荷が変動する場合や加工精度を要求される場合には、回転速度を抑えてご使用下さい。
- 推奨傾斜切込み角度以上で加工される場合には、送り速度を下げてください。
- 切込深さが切削条件表より小さい場合、送り速度を最大150%を目安に調整して加工も可能です。
- 切込深さが切削条件表より大きくなる場合は、最大60%に減速する事で安定した加工が可能です。

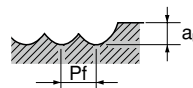

ボールエンドミルをご使用の場合、「同工具径の」ラジウスエンドミルと比較して、前カッタパス(LAST PITCHがない状態)における削り残し(コーナー R部の大きさによる切削抵抗による工具の倒れが大きい)が多いため、荒(削り残し補正)・仕上げ加工の2回(右の図の2重線の様に)に分けて等高線加工をする事によってリブ溝の「加工」精度を上げることができます。
In comparison to the same tool diameters of radius end mill, ball end mill machine less material per pass (large corner radius generate cutting resistance which tilt ball end mill largely). In order to improve the precision of the ribs, please separate the contour milling in roughing (correction of unmachined area) and finishing (shown as double lined area in figure on right) procedure.

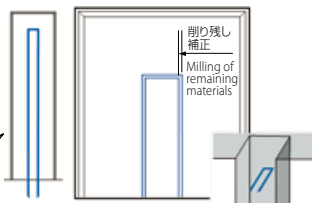

NEXT



FROM

被削材 Work Material		びびり抑制条件 Vibration control conditions																	
		快削材 高能率荒取り条件 ~40HRC High feed roughing of free-cutting materials				高じん性金型材 中荒取り条件 38 ~ 53HRC Semi-roughing in high toughness mold materials				溝加工条件 ~53HRC Machining Conditions For Slotting				仕上げ加工条件 ~55HRC Machining Conditions For Finishing					
		調質鋼・プリハードン鋼 Hardened Steel · Prehardened Steel																	
RE	首下長 LU	推奨傾斜 切込角度 Recommended Cutting Angle	SKT4 · SKD61 · NAK80 · HPM1 · DH**				DH** · DAC**				SKT4 · SKD61 · NAK80 · HPM1 · DH**				SKT4 · SKD61 · NAK80 · HPM1 · DH**				
			回転速度 Speed (min ⁻¹)	送り速度 Feed (mm/min)	切込深さ(mm) Depth of Cut		回転速度 Speed (min ⁻¹)	送り速度 Feed (mm/min)	切込深さ(mm) Depth of Cut		回転速度 Speed (min ⁻¹)	送り速度 Feed (mm/min)	切込深さ(mm) Depth of Cut		回転速度 Speed (min ⁻¹)	送り速度 Feed (mm/min)	切込深さ(mm) Depth of Cut		仕上げ代 (mm) Clearance
			a _p	P _f	a _p	P _f	a _p	P _f	a _p	P _f	a _p	P _f	a _p	P _f	a _p	P _f			
R6	45	0.5°	3,200	1,700	0.8	2	2,000	800	0.8	1.8	2,000	800	0.6	0.15	3,200	2,400	0.36	0.32	0.15
	60		2,500	1,300	0.65	2	2,000	800	0.65	1.8	2,000	800	0.5	0.15	2,500	1,900	0.36	0.32	0.15
	70		2,100	1,100	0.57	2	2,000	800	0.57	1.8	2,000	800	0.5	0.1	2,100	1,600	0.36	0.32	0.1
	85		1,800	950	0.42	1.8	1,500	600	0.42	1.7	1,500	600	0.4	0.1	1,800	1,350	0.36	0.32	0.1
	100		1,300	690	0.3	1.8	1,200	500	0.3	1.7	1,200	500	0.3	0.1	1,300	980	0.36	0.32	0.1
	120		1,000	530	0.25	1.5	1,000	420	0.25	1.5	-	-	-	-	1,000	750	0.36	0.32	0.05
	140		900	470	0.2	1.5	900	380	0.2	1.5	-	-	-	-	900	680	0.36	0.32	0.05
	160	700	370	0.15	1.3	700	300	0.15	1.3	-	-	-	-	700	530	0.36	0.32	0.05	
R8	55	0.5°	2,400	1,600	1	2.2	1,500	600	1	1.8	1,500	600	0.8	0.15	2,400	2,400	0.48	0.4	0.2
	80		1,900	1,250	0.9	2.2	1,500	600	0.9	1.8	1,500	600	0.8	0.15	1,900	1,900	0.48	0.4	0.15
	90		1,600	1,050	0.75	2.2	1,500	600	0.75	1.8	1,500	600	0.7	0.1	1,600	1,600	0.48	0.4	0.1
	105		1,400	900	0.55	2	1,400	570	0.55	1.7	1,400	570	0.5	0.07	1,400	1,400	0.48	0.4	0.07
	120		1,000	650	0.4	2	1,000	420	0.4	1.7	1,000	420	0.4	0.05	1,000	1,000	0.48	0.4	0.05
	150	800	500	0.4	2	800	340	0.4	1.7	800	340	0.4	0.05	800	720	0.48	0.4	0.05	
R10	70	0.5°	1,900	1,500	1.2	3.6	1,200	500	1.2	1.8	1,200	500	0.8	0.15	1,900	2,400	0.6	0.5	0.2
	90		1,500	1,200	1.1	3.6	1,200	500	1.1	1.8	1,200	500	0.8	0.15	1,500	1,900	0.6	0.5	0.15
	110		1,300	1,000	0.9	3.5	1,200	500	0.9	1.8	1,200	500	0.8	0.1	1,300	1,600	0.6	0.5	0.1
	130		1,100	850	0.7	3.4	1,100	450	0.7	1.8	1,100	450	0.7	0.1	1,100	1,400	0.6	0.5	0.07
	150		760	600	0.5	3.3	760	320	0.5	1.8	760	320	0.5	0.07	760	950	0.6	0.5	0.05

1. The above mentioned conditions according to projection lengths are intended as general guidelines for reference only. Adjustments should be made based on actual milling conditions.
2. For 0.5R-2.5R, the machining conditions are based on chucking the tool up to the base of the neck.
3. Use a rigid and precise machine and holder.
4. Tool vibrations should be kept at a minimum level for maximum accuracy.
5. In the case of linear machining, do not use the P_f value, instead refer to the a_p value.
6. More stable high-feed machining in the corners can be attained by setting an R insertion or deceleration on the CAM or machine side.
7. When cutting load fluctuates (in the corners, etc.) or when high precision is required, be sure to control the rotational speed.
8. When cutting at greater than the recommended cutting angle, reduce the feed.
9. When the depth of cut is less than the specified amount as listed above, the feed rate can be increased up to 150%.
10. When the depth of cut is greater than the specified amount as listed above, the feed rate can be reduced by no more than 60% to ensure stable milling.

Phoenix シリーズの能力をより発揮させるために

To maximize performance of the Phoenix Series

■ 切削条件の計算式 How to calculate cutting conditions

切削条件を考える時に下の式を使うと便利!
When you calculate the cutting conditions, it is much more convenient if you use the following equations!

[計算式]

n = 回転速度 (min⁻¹)

$$n = Vc \div 3.14 \div DC \times 1,000$$

*DCは外径
DC=diameter

Vc = 切削速度 (m/min)

$$Vc = n \times 3.14 \times DC \div 1,000$$

*DCは外径
DC=diameter

Vf = 送り速度 (mm/min)

$$Vf = n \times ZFPP \times fz$$

*ZFPPは刃数
ZFPP=number of flute

fz = 1刃当たりの送り量 (mm/t)

$$fz = Vf \div ZFPP \div n$$

*ZFPPは刃数
ZFPP=number of flute

また、カスプハイト、ピックフィードにも配慮下さい。
カスプハイト、ピックフィードは下記参照下さい。

Also take the cusp height and pick feed into account.
The cusp height and pick feed are indicated as below.

例 PHX-DFR φ10×R2を電卓で計算する場合
Calculating the PHX-DFR φ10×R2 with a calculator



使用工具 Tool	PHX-DFR φ10×R2
切削速度 Cutting Speed	39.25m/min (1,250min ⁻¹)
送り速度 Feed	1,500mm/min (0.4mm/t)

$$n = Vc \div 3.14 \div DC \times 1,000$$

$$= 39.25 \text{m/min} \div 3.14 \div \phi 10 \times 1,000$$

$$= 1,250 \text{min}^{-1}$$

$$Vc = n \times 3.14 \times DC \div 1,000$$

$$= 1,250 \text{min}^{-1} \times 3.14 \times \phi 10 \div 1,000$$

$$= 39.25 \text{m/min}$$

$$Vf = n \times ZFPP \times fz$$

$$= 1,250 \text{min}^{-1} \times 3 \text{刃} \times 0.4 \text{mm/t}$$

$$= 1,500 \text{mm/min}$$

$$fz = Vf \div ZFPP \div n$$

$$= 1,500 \text{mm/min} \div 3 \text{刃} \div 1,250 \text{min}^{-1}$$

$$= 0.4 \text{mm/t}$$

■ カスプハイトの求め方 (mm) The value of cusp height (mm)

[計算式]

h = カスプハイト (mm)

$$h = R - \sqrt{R^2 - \left(\frac{Pf}{2}\right)^2}$$

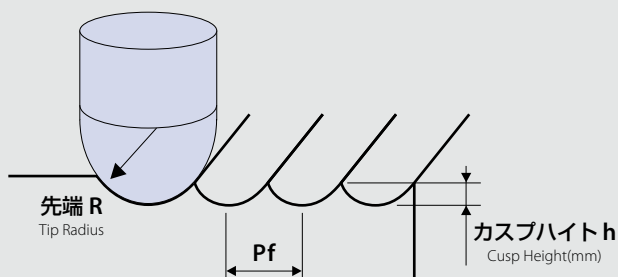

例 PHX-DBT R5×100 Pfが0.3mmを電卓で計算する場合
Ex. Calculating the PHX-DBT R5×100 with a calculator

$$h = R - \sqrt{R^2 - \left(\frac{Pf}{2}\right)^2}$$

$$= 5 - \sqrt{5 \times 5 - \left(\frac{0.3 \div 2}{2}\right)^2}$$

$$= 5 - \sqrt{25 - 0.0225}$$

$$= 5 - \sqrt{24.9775}$$

$$= 5 - 4.99775$$

$$h = 0.00225 \text{mm}$$

■ 中仕上げ、仕上げ加工の切込み量の目安 (mm) Approximate depth of cut for semi-finishing and finishing

・中仕上げの切込み量目安
Approximate depth of cut for semi-finishing

$$R \times ap0.13$$

・仕上げの切込み量目安
Approximate depth of cut for finishing

$$R \times ap0.06$$



Phoenix シリーズの能力をより発揮させるために

To maximize performance of the Phoenix Series

PHX-PC (ペンシルネック) シリーズの突出し長さ換算表

Overhang conversion table of the PHX-PC (Pencil Neck) Series

ペンシルネック形状による剛性アップを、突出し長さとして換算する為の表です。
下記表を用いて突出し長さを算出し、切削条件の参考にして下さい。

The following table is to calculate the new overhang length, since rigidity has been improved with the use of Pencil Neck.
Please use below as a reference for your cutting condition.

[公式] **手順1** 突出し長さ ÷ 工具外径 = L/D **手順2** 突出し長さ × 割合 = ストレートシャック換算の突出し長さ

Step1 Overhang Length Mill. Diameter Step2 Overhang Length Percentage Converted overhang length for straight shank

例) PHX-PC-DBT R3 × 2° × 62.3 で、突出し長さを 65mm で加工した場合(赤丸部分) Ex.) PHX-PC-DBT R3 × 2° × 62.3, milling with an overhang of 65mm

手順1 (突出し長さ: 65mm) ÷ (工具外径: φ6) = 10.83D → 約11D 下記表から「11Dの2°」の割合(63.8%)を確認
Step1 Overhang Length Mill. Diameter Approximately 11D: confirm the percentage from the below table "11D and 2°"(63.8%)

手順2 (突出し長さ: 65mm) × (割合: 63.8%) = 41.47mm → ストレートシャック換算で突出し長さ 45mm の切削条件を参考に設定
Step2 Overhang Length Percentage Based on this straight shank conversion, the overhang is calculated to be 45 mm. Please refer to it as the new cutting condition.

▶ ペンシルネックを使うことによって、突出し長さ 65mm でも、ストレートシャックの 45mm 相当の切削条件で削ることが出来、**剛性が確保** 出来ます。
By utilizing the Pencil Neck, even if the overhang is 65 mm, the milling condition can be set equivalent to a 45 mm straight shank tool while keeping the same rigidity.

注) 上記は工具単体での剛性を計算した割合です。実際に使用するホルダ、機械等の剛性によって調整下さい。

Note: The above percentages are calculated based on the rigidity of the tool only. Please make necessary adjustments based on the conditions of your tool holder and machining center.

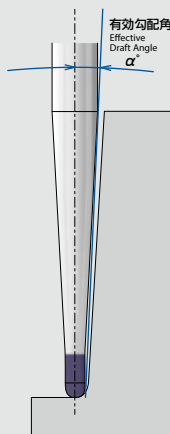

有効勾配角 Effective Draft Angle α°	突出し長さ L/D	首部テーパ半角 θn																
		3D	4D	5D	6D	7D	8D	9D	10D	11D	12D	13D	14D	15D	16D	20D		
0.5°		99.7%	98.3%	96.6%	95.2%	93.6%	92.1%	90.7%	89.3%	88.0%	86.7%	85.4%	84.1%	82.9%	81.8%	77.4%		
1°		98.3%	95.5%	92.6%	89.8%	87.1%	84.6%	82.2%	80.0%	77.9%	75.9%	74.0%	72.2%	70.5%	68.8%	62.9%		
1.5°		97.0%	93.0%	88.8%	85.2%	81.6%	78.4%	75.4%	72.7%	70.1%	67.7%	65.5%	63.4%	61.4%	59.6%	53.2%		
2°		95.7%	90.5%	85.6%	81.0%	76.9%	73.1%	69.8%	66.7%	63.8%	61.3%	58.8%	56.6%	54.6%	52.7%	46.2%		

この表は、2°以下の剛性の弱いサイズに活用下さい。2°を超えるサイズに関しては、加工に応じて条件を設定して下さい。
Please use this chart for sizes under 2° with low rigidity. For sizes over 2°, please adjust accordingly based on milling condition.

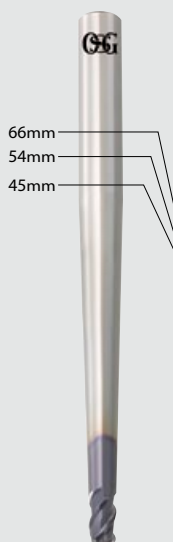

突出し長さが長くなっても、一刃あたりの送り量は落としません。
シングルネックタイプなら、同一工具で突出し長さを変えて加工ができます。

Even with a long overhang length, feed per cutting edge will not decrease.
Single-neck type offers continuous machining with the same tool by simply changing the overhang length.

PHX-PC-DBT (R3 × 1.5° × 43.2) を用いた中仕上げ工程

Semi-finishing process using PHX-PC-DBT (R3 × 1.5° × 43.2)

突出し長さ Overhang Length		回転速度 Speed (min ⁻¹)	切削速度 Cutting Speed (m/min)	送り速度 Feed (mm/min)	一刃あたりの 送り量 Feed per Tooth (mm/t)	切込深さ Depth of Cut (mm)	
mm	L/D					ap	Pf
45	7.5	4,300	80	3,600	0.28	0.5	1.3
54	9	2,670	50	3,240	0.4	0.34	1
66	11	1,660	30	2,590	0.52	0.23	1



工具の焼きばめには…

For tool shrink fit...

OSG-HAIMER Power Clamp

ニーズに合わせて5つのパッケージをご用意

5 packages available based on needs

カタログはこちら

Scan for product catalog



- シャンク径 $\phi 3 \sim \phi 50$ の工具に対応^{*1}
Applicable to $\phi 3 \sim \phi 50$ of tool shank diameter
- 短時間での加熱・冷却が可能
Short heating and cooling time
- 高い安全性
High level of safety
 - 高熱部分に触れることが少ない設計
A design decreasing the danger of touching highly heated areas
 - オーバーヒート防止機能付き
Equipped with an overheating prevention function
- 操作性の良さ
Easy to operate
- メンテナンス不要
Maintenance-free

^{*1} スタンダードプラス及びプレミアムパッケージの場合です。
詳細はOSG-HAIMERカタログをご参照下さい。

^{*1} For Standard Plus and Premium package. Please refer to the OSG-HAIMER catalog for details.

加工前のプリセットや測定には…

For presetting and measurement before processing...

OZTツールプリセッタ Tool Presetter

ニーズに合わせて3つのタイプをご用意

3 types of machines available to accommodate various requirements

カタログはこちら

Scan for product catalog



- 最新の画像システムにより操作が簡単
Easy operation with the latest imaging system
- Bosch社製の空気制御、THK社製のガイドウェイ、ハイデンハイン社製のガラススケールの使用で長期メンテナンスが不要
Incorporation of high-quality components, including the Bosch air control, THK guideway and Heidenhain glass scale to minimize maintenance long term
- 自動刃先認識システムにより非接触で正確な測定
Non-contact and accurate measurement by the automatic cutting edge recognition system
- 切削・旋盤工具の測定、セット、検査が一度に可能
Quick, easy and precise measurement and presetting of cutting and turning tools all-in-one
- ドイツZOLLER社製の高品質をミニマムプライスで
German manufacturer ZOLLER's high quality product at affordable pricing





shaping your dreams

本 社 〒442-8543 愛知県豊川市本野ヶ原三丁目22番地 TEL(0533)82-1111
E-mail : cs-info@osg.co.jp Web : https://www.osg.co.jp/

International Headquarters 3-22 Honnogahara, Toyokawa, Aichi, 442-8543, JAPAN
TEL : +81-533-82-1118 FAX : +81-533-82-1136

東部営業部 〒143-0025 東京都大田区南馬込3-25-4 TEL(03)5709-4501

中部営業部 〒465-0058 愛知県名古屋市名東区貴船1-9 TEL(052)703-6131

西部営業部 〒550-0013 大阪府大阪市西区新町2-4-2 405号 TEL(06)6538-3880

仙 台 TEL(022) 390-9701
郡 山 TEL(024) 991-7485
新 潟 TEL(025) 286-9503
上 田 TEL(0268) 28-7381
諏 訪 TEL(0266) 58-0152
岡 毛 TEL(0270) 40-5855
宇都宮 TEL(028) 651-2720
八王子 TEL(042) 645-5406
茨 城 TEL(029) 354-7017
東 京 TEL(03) 5709-4501
厚 木 TEL(046) 230-5030
静 岡 TEL(054) 283-6651
浜 松 TEL(053) 461-1121
豊 川 TEL(0533) 82-1145
安 城 TEL(0566) 77-2366

名古屋 TEL(052) 703-6131
岐 阜 TEL(058) 259-6055
トヨタ TEL(0533) 82-1145
三 重 TEL(0594) 26-0416
東 海 TEL(052) 703-6131
金 沢 TEL(076) 268-0830
京 滋 TEL(077) 553-2012
大 阪 TEL(06) 6747-7041
明 石 TEL(078) 927-8212
岡 山 TEL(086) 241-0411
四 国 TEL(087) 868-4003
広 島 TEL(082) 507-1227
九 州 TEL(092) 504-1211
北九州 TEL(093) 435-3655
熊 本 TEL(096) 386-5120

〈工具の技術的なご相談は…〉 コミュニケーションダイヤル

よ い 工 具 は 一 番

0120-41-5981 土日祝日、
会社休日を除く

コミュニケーション FAX 0533-82-1134 コミュニケーション E-mail hp-info@osg.co.jp

安全にお使いいただくために

- 工具を使用する時は、破損する危険があるので、必ずカバー・保護メガネ・安全靴等を使用して下さい。
- 切れ刃は素手でさわらないで下さい。
- 切りくずは素手でさわらないで下さい。
- 工具の切れ味が悪くなったら使用を中止して下さい。
- 異常音・異常振動が発生したら、直ちに使用を中止して下さい。
- 工具には手を加えないで下さい。
- 加工前に工具の寸法確認を行って下さい。

Safe use of cutting tools

- Use safety cover, safety glasses and safety shoes during operation.
- Do not touch cutting edges with bare hands.
- Do not touch cutting chips with bare hands. Chips will be hot after cutting.
- Stop cutting when the tool becomes dull.
- Stop cutting operation immediately if you hear any abnormal cutting sounds.
- Do not modify tools.
- Please use appropriate tools for the operation. Check dimensions to ensure proper selection.

OSG代理店

Copyright © 2015 OSG Corporation. All rights reserved.

- 製品については、常に研究・改良を行っておりますので、予告なく本カタログ掲載仕様を変更する場合があります。 Tool specifications are subject to change without notice.
- 本書掲載内容の無断転載・複製を禁じます。

N-72.913.BE.CHA(DN)
19.07

オーエスジー株式会社